

Downloadable Sounds Level 2.1

Version 1.0

February 2000

Including Mod LFO to Gain Changes

Published By:

The MIDI Manufacturers Association

Los Angeles, CA

PREFACE

The MMA's Downloadable Sounds Specification Level 2 (DLS-2) is a logical extension of DLS-1 intended to be in-line with what is commonly considered state of the art today in multimedia computing. The specification is the result of collaboration between numerous hardware and software manufacturers represented by the MMA, as well as input from other organizations intending to use the format, such as MPEG (IEC/ISO JTC-1 SC-29 WG-11).

This document describes the new playback device architecture as well as extensions to the file format which support additional DLS-2 specific chunks. For complete details of the Level 1 format, please consult the MMA's Downloadable Sound Specification (Level 1) document.

DLS playback device must be able to accurately, within specific guidelines, play back files properly authored to this specification. **Certification of DLS compatibility is therefore required of all Manufacturers of DLS compatible devices and related products.** Companies should contact the MMA to receive information about testing procedures, and obtain test materials and certification.

The MMA and all companies involved in the development of DLS-2 shall not be held liable to any person or entity for any reason related to the adoption, implementation or other use of this document or the specification herein.

NOTE: All references to DLS Level 2 in this document also apply to DLS Level 2.1.

Changes from DLS Level 2 to DLS Level 2.1:

- Reformatted Section 3.0
- New Section 3.4 (Description of Mod LFO to Gain change for DLS 2.1)
- Table 1 modified so that Mod LFO to Gain is now Bipolar non-inverted.

Downloadable Sounds Level 2.1 Specification

RP-025-Amd1

Copyright © 1998 and 2000 MIDI Manufacturers Association Incorporated

ALL RIGHTS RESERVED. NO PART OF THIS DOCUMENT MAY BE REPRODUCED OR TRANSMITTED IN ANY FORM OR BY ANY MEANS, ELECTRONIC OR MECHANICAL, INCLUDING INFORMATION STORAGE AND RETRIEVAL SYSTEMS, WITHOUT PERMISSION IN WRITING FROM THE MIDI MANUFACTURERS ASSOCIATION.

Printed 2000

MMA

PO Box 3173

La Habra CA 90632-3173

TABLE OF CONTENTS

1.	SYNTHESIS MODEL	1
1.1	ABSTRACT	1
1.2	OVERVIEW OF SYNTHESIZER MODEL	1
1.2.1	<i>Control Logic</i>	2
1.2.2	<i>Digital Audio Engine</i>	3
1.2.3	<i>Articulation Modules and Connections</i>	3
1.3	MINIMUM DEVICE REQUIREMENTS	4
1.4	SYNTHESIZER DESIGN DETAIL.....	4
1.4.1	<i>Control Logic</i>	4
1.4.2	<i>Articulation Data</i>	5
1.4.3	<i>Conditional Chunks</i>	5
1.4.4	<i>Note Exclusivity</i>	5
1.4.5	<i>Voice Allocation</i>	6
1.4.6	<i>Bank Select and Program Change</i>	7
1.4.7	<i>Phase-Locked Samples</i>	7
1.5	DIGITAL AUDIO ENGINE.....	7
1.5.1	<i>Digital Oscillator</i>	7
1.5.2	<i>Digitally Controlled Filter</i>	8
1.5.3	<i>Digitally Controlled Amplifier</i>	12
1.6	ARTICULATION MODULES AND CONNECTIONS	12
1.6.1	<i>Signal Flow</i>	12
1.6.2	<i>Connection Block</i>	13
1.6.3	<i>Default, Global and Local Articulation Data</i>	14
1.6.4	<i>Controller Theory</i>	14
1.6.5	<i>Transforms</i>	14
1.7	GENERATORS	17
1.7.1	<i>Low Frequency Oscillator</i>	17
1.7.2	<i>Envelope Generator</i>	17
1.7.3	<i>Key Number Generator</i>	21
1.8	PERFORMANCE CONTROLLERS	21
1.8.1	<i>Note Number</i>	21
1.8.2	<i>Volume</i>	22
1.8.3	<i>Expression</i>	22
1.8.4	<i>Velocity</i>	22
1.8.5	<i>Pan</i>	22
1.8.6	<i>MIDI Controller 1 (Modulation)</i>	23
1.8.7	<i>Channel Pressure</i>	23
1.8.8	<i>Pitch Bend</i>	23
1.8.9	<i>MIDI Controller 64 (Sustain)</i>	23
1.8.10	<i>MIDI Controller 91 (Reverb)</i>	23
1.8.11	<i>MIDI Controller 93 (Chorus)</i>	23
1.8.12	<i>Registered Parameter Numbers (RPN)</i>	23
1.8.13	<i>Registered Parameter Number Data Entry</i>	24

DOWNLOADABLE SOUNDS LEVEL 2.1

1.9	CHANNEL MODE MESSAGES	24
1.9.1	Reset All Controllers (MIDI Controller 121).....	24
1.9.2	All Notes Off (MIDI Controller 123).....	25
1.9.3	All Sound Off (MIDI Controller 120).....	25
1.9.4	Other Channel Mode Messages	25
1.10	ACTIVE SENSING (0xFE)	25
1.11	POWER-ON DEFAULT VALUES	25
1.12	ARTICULATION ARCHITECTURE	25
1.13	MODULATION ROUTING.....	26
1.13.1	Default Connections.....	26
1.14	DATA FORMAT DEFINITIONS.....	32
1.14.1	Absolute Pitch	32
1.14.2	Relative Pitch.....	32
1.14.3	Absolute Time.....	32
1.14.4	Gain	32
1.14.5	Sample Frequency	32
1.14.6	Instrument	32
1.14.7	Region.....	33
1.14.8	Wave Link.....	33
1.14.9	Articulation.....	33
1.14.10	Wave Sample	34
1.15	TOLERANCES	34
1.15.1	Digital Oscillator	34
1.15.2	Digitally Controlled Filter.....	34
1.15.3	Digitally Controlled Amplifier.....	35
1.15.4	LFO Generator.....	35
1.15.5	Envelope Generator.....	35
1.16	DLS SYSTEM EXCLUSIVE MESSAGES	36
2.	DLS FILE RIFF STRUCTURE.....	37
2.1	RIFF FORMAT.....	37
2.2	RIFF STRUCTURE.....	37
2.3	LIST CHUNK	40
2.4	<COLH-CK>, COLLECTION HEADER CHUNK.....	40
2.5	<DLID-CK>, DLSID CHUNK	40
2.6	<CDL-CK>, CONDITIONAL CHUNK.....	42
2.6.1	DLS Level 1 and Level 2 Compatibility.....	44
2.7	<INSH-CK>, INSTRUMENT HEADER CHUNK.....	45
2.8	<RGNH-CK>, REGION HEADER CHUNK	45
2.9	<ART1-CK>, LEVEL 1 ARTICULATOR CHUNK.....	46
2.10	<ART2-CK>, LEVEL 2 ARTICULATOR CHUNK.....	49
2.11	<WLNK-CK>, WAVE LINK CHUNK	53
2.12	<WSMP-CK>, WAVE SAMPLE CHUNK.....	54
2.13	<PTBL-CK>, POOL TABLE CHUNK	55
2.14	<VERS-CK>, VERSION CHUNK.....	56
2.15	<INFO-LIST>, INFO LIST CHUNK.....	57

2.16	DLS WAVE FILE FORMAT	59
2.16.1	Format Chunk <fmt-ck>	59
2.16.2	Data Chunk <data-ck>	60
2.16.3	Data Packing for WAVE_FORMAT_PCM Files	60
2.16.4	Data Packing for 8-Bit Mono PCM	61
2.16.5	Data Packing for 8-Bit Stereo PCM	61
2.16.6	Data Packing for 16-Bit Mono PCM	61
2.16.7	Data Packing for 16-Bit Stereo PCM	61
2.16.8	Data Format of the WAVE_FORMAT_PCM Samples	61
2.17	INSTRUMENT OBJECT HIERARCHY	62
2.18	PROPRIETARY CHUNK IDS	63
2.19	FILE EXAMPLES	64
2.19.1	Generic DLS Level 1 File	64
2.19.2	DLS Level 1 File With 3rd Party Extensions	65
2.19.3	Generic DLS Level 2 File	67
3.	COMPATIBILITY NOTES	68
3.1	CODING REQUIREMENTS AND RECOMMENDATIONS	68
3.2	DLS LEVEL 1 AND LEVEL 2 COMPATIBILITY	68
3.3	DLS LEVEL 1 COMPATIBILITY	69
3.4	MOD LFO TO GAIN CHANGE (DLS 2.1)	69
3.5	DLSID INTEGRITY	69
4.	DLS HEADER FILES	71
4.1	DLS LEVEL 1 HEADER FILE	71
4.2	DLS LEVEL 2 HEADER FILE	76
5.	REFERENCES	78

TABLE OF FIGURES

FIGURE 1: BLOCK DIAGRAM.....	2
FIGURE 2: CONTROL LOGIC	4
FIGURE 3: FORWARD LOOP	8
FIGURE 4: LOOP AND RELEASE	8
FIGURE 5: LOW PASS FILTER.....	9
FIGURE 6: FILTER RESONANCE.....	10
FIGURE 7: FILTER CUTOFF FREQUENCY	10
FIGURE 8: CONNECTION BLOCK	13
FIGURE 9: INPUT TRANSFORMS	16
FIGURE 10: ENVELOPE.....	18
FIGURE 11: PAN CURVE	22
FIGURE 12: DLS FILE FORMAT	39
FIGURE 13: USTRANSFORM FIELD.....	49

1. Synthesis Model

1.1 Abstract

As music synthesis architectures have become increasingly prevalent, so too has the need for a standard format for defining musical instruments. Although the General MIDI (GM) specification for 128 instrument presets helps to a small degree, it lacks both the depth and breadth to deliver a truly consistent playback experience across a wide range of platforms. There exists a need for a musical instrument standard that allows composers to define exactly how each musical instrument sounds on a wide variety of playback devices.

In January 1997, the MIDI Manufacturers Association ratified the first industry-wide standard for transporting complete sounds between synthesizers. The Downloadable Sounds Level 1 Specification (DLS-1) defines a first order cross-platform synthesizer model that allows developers to target a large range of playback devices with a single set of content while still maintaining consistent playback across all those platforms. Further extensions to that architecture have been added in this specification.

It is important to understand that this specification defines a purely symbolic system that can be mapped onto many different designs. It should not be viewed as a recipe for a specific synthesis architecture, but rather as a flexible language for mapping common features across various design implementations.

1.2 Overview of Synthesizer Model

The DLS Level 1 synthesizer consists of the following basic elements for each voice:

- A sampled sound source with loop points
- Two 4-segment envelope generators characterized as ADSR (Attack-Decay-Sustain-Release)
- One Low Frequency Oscillator (LFO) generators
- Standardized response to MIDI controllers

The DLS Level 2 synthesizer consists of the following basic elements for each voice:

- A sampled sound source with loop and release
- Two 6-segment envelope generators characterized as DAHDSR (Delay-Attack-Hold-Decay-Sustain-Release)
- Two Low Frequency Oscillator (LFO) generators
- A low pass filter with resonance and dynamic filter cutoff frequency
- Standardized response to MIDI controllers

A musical instrument defined in DLS is much more than a simple collection of audio samples. In addition to the actual sample data and associated loop information, the instrument must indicate under what circumstances each sample should be used, and how to modulate, or articulate, the sample as it plays. A typical synthesizer architecture can be broken down into three distinct subsystems:

- Control logic
- Digital audio engine
- Articulation modules and connections

1.2.1 Control Logic

The control logic receives a MIDI note event and determines which instrument should play the note, and, within that instrument, which sample and articulation combination to use.

Choosing the instrument requires little more than observing the MIDI channel number in the event and selecting the proper instrument accordingly.

Choosing the sample and articulation to use is not as simple. Almost all sampled synthesis architectures employ some method of organizing samples by note range across the keyboard. In addition, individual samples can be assigned to different velocity ranges or multiple samples can be played at once to create a richer, layered sound.

Terms such as layers, splits, blocks, and regions are commonly used in synthesizer jargon to refer to the management of multiple samples. For the purposes of this specification, they are referred to as *regions*. Regions are described further in the Synthesizer Design Detail section (Section 1.4).

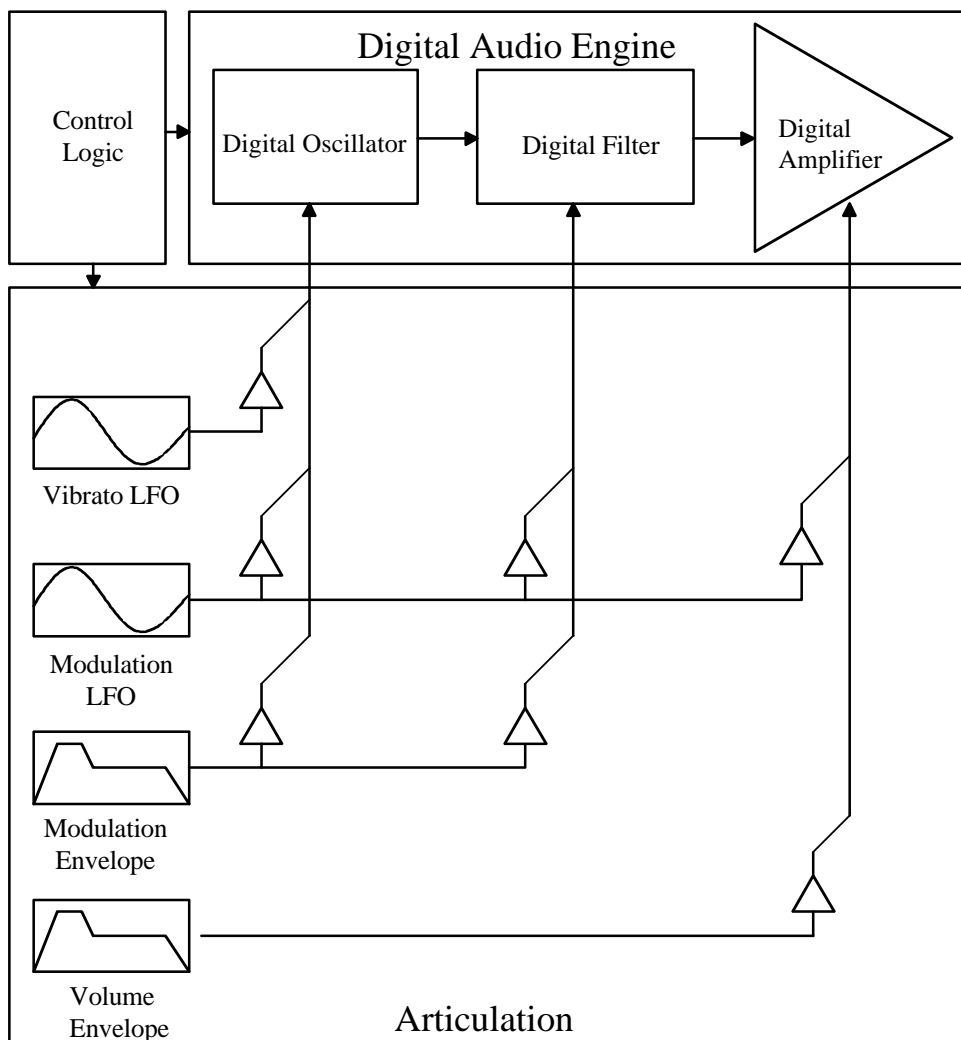

Figure 1: Block Diagram

1.2.2 Digital Audio Engine

The digital audio engine is the most obvious part of the synthesizer. It is composed of a playback engine (a digital oscillator), a digitally controlled filter, and a digitally controlled amplifier.

The digital oscillator plays a sampled sound waveform, managing loop points within the waveform so the sound can play continuously if needed. As the note plays, it can respond to changes in pitch, allowing for real-time expression such as vibrato and pitch bend.

The digitally controlled filter is a two-pole low-pass filter with dynamically controlled cutoff frequency and a programmable resonance. Typical applications for the filter include varying the amount of high frequency content according to MIDI velocity or applying the modulation envelope to reduce the upper harmonics over time to simulate acoustic instruments.

The digitally controlled amplifier modulates the volume of the instrument. Most importantly, this is used to control the amplitude shape, or envelope, of the note. It is also used for other types of real-time expression, such as tremolo.

Pitch, filtering, and volume control of the oscillator and amplifier are critical because they define the shape of the sound as it plays, and allow it to be dynamically responsive in real time, giving the sampled instrument much more expression than simple digital audio playback could ever provide. Real-time control of these parameters comes from modules in the Articulation section, which generate a constant stream of changing pitch, filter, and volume messages to which the digital audio engine responds.

The digital audio path represents the journey the sound takes from the oscillator to the filter, from there to the amplifier, and then to the digital-to-analog converter (DAC). This path can optionally include additional modules, such as effects devices, that process the sound as it flows from oscillator to DAC.

1.2.3 Articulation Modules and Connections

The articulation modules are a set of devices that provide additional control over the pitch, filtering and volume of the sample as it plays.

The articulation modules include low frequency oscillators (LFOs) to contribute vibrato and tremolo, envelope generators to define an overall volume and pitch shape to the sample, and MIDI real-time controllers, such as Pitch Bend and Modulation controller, to give the music real-time expression.

Generally, these modules can be linked in different ways to provide different results. For example, an LFO might generate a sine or triangle wave, which modulates the pitch of the sample for vibrato or the volume of the sample for tremolo. Modules can also receive as well as send control signals. An envelope generator might use key velocity to influence the attack time of the envelope or the cutoff frequency of the low-pass filter.

Articulation modules can be configured in different ways, and this configuration is an important part of the instrument definition. In fact, the term *patch*, as used for an instrument preset, refers to the early days when the hardware modules in an analog synthesizer were "patched" together with cables, which routed signals from module to module.

The ability to configure the modules is important because it yields a flexible approach to synthesizer design. At the same time, it is important to define a base-level configuration that can be supported by all hardware. This specification maps the routing onto a flexible system, allowing for future expansion to encompass not only extensions of wavetable synthesis, but other forms of musical synthesis as well.

1.3 Minimum Device Requirements

The device must meet the following minimum requirements to be considered compliant with the DLS Level 2 specifications:

- Minimum of 32 digital oscillators each with individually controlled DCA, DCF, LFO generators (two per oscillator), and envelope generators (two per oscillator).
- Minimum sample playback rate of 22.05 KHz
- Minimum sample memory of 1,048,576 x 16-bit words
- Minimum of 512 waves stored simultaneously (subject to sample memory constraints)
- Minimum of 256 instruments stored simultaneously (subject to articulation data constraints)
- Minimum of 1,024 regions stored simultaneously (subject to articulation data constraints)
- Minimum of 8,192 explicit connections stored simultaneously (does not include default connections)
- If the device claims support for both DLS and GM, it must be able to support both of them simultaneously without encroachment on the above minimum requirements

1.4 Synthesizer Design Detail

1.4.1 Control Logic

The control logic implementation is relatively simple. The control logic receives MIDI Bank Select and Program Change commands to select the instrument on a particular channel, and MIDI Note-On and Note-Off events to play notes on the same channel.

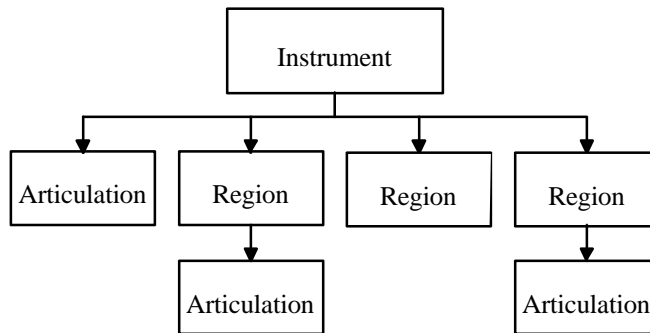

Figure 2: Control Logic

The control logic uses the combination of instrument choice (bank select and program change) and note to select a specific configuration of the articulation modules and digital audio engine to perform the note.

The control logic must select a specific sample for the digital audio engine to play. The sample is indirectly accessed through a region. The region defines the key range and velocity range used by the control logic to select the sample. It also determines a preset value for the overall amplitude of the sample and a preset tuning. The sample, in turn, defines the actual chunk of digitized sound, along with control parameters such as loop points, sample rate, and so on.

1.4.2 Articulation Data

The *articulation* is a complete configuration of articulation modules and their connections, including the envelope generators and LFOs. These define how the note should be articulated as it plays.

An instrument is composed of one or more regions, which in turn define the range of notes and velocities which that particular region should play, the sample that should be played, and the articulation that should be applied to the sample data by the digital audio engine. Layering is facilitated through the use of overlapping note regions, with each region using up an oscillator in the device. Velocity splits are facilitated through the use of overlapping note regions with different velocity ranges, while key splits are facilitated similarly by overlapping velocity ranges with different note ranges.

Articulation data can either be global to the entire instrument, or it can be local to a specific region within the instrument. Local articulation data always takes precedence over global articulation data. Global articulation data determines the default behavior of the instrument. Local articulation can be used to modify the behavior of a particular region.

A connection in the articulation data consists of a Destination within the synthesizer, a Source, and a Control, either of which may be internal or external. The combination of Destination, Source, and Control make a unique connection. The DLS Level 2 specification defines default behavior or "implied" connections in the absence of any articulation data. The synthesizer executes each implied connection unless the articulation data in the instrument specifically overrides it.

For example, the default connection "Mod LFO Frequency", which has Source "SRC_NONE", Control "SRC_NONE" and Destination "DST_LFO_FREQ" (See Modulation Routing Table) sets the Modulation LFO frequency to 5 Hz. To override this, the articulation must specify the exact same Source, Control and Destination along with the new frequency.

Global articulation data either augments, or as shown above, overrides the implied connections, creating a new set of default connections for the instrument. Similarly, local articulation data augments or overrides the implied connections, and overrides any global articulation data.

This document describes a number of sources, destinations and various transforms that can be applied to the connections between them. It also describes a fixed set of routing connections that *must* be implemented in order for a synthesizer to be DLS Level 2 compliant. However, these fixed connections represent a small fraction of the universe of connections that are possible. Developers are free to use these other connections in a DLS file, provided that they are protected by Conditional Chunks to guard them from unwitting access by devices that are not expecting such connections.

1.4.3 Conditional Chunks

DLS Level 2 introduces new functionality into the control logic, namely a block called a "Conditional Chunk." Conditional Chunks can be used to create libraries that are both forward and backward compatible. As an example, an instrument in a library may contain DLS Level 1 chunks, DLS Level 2 chunks, and chunks for a proprietary device. The file parser will then select the appropriate chunks for the specific device in use. A detailed description of the Conditional Chunk can be found in the section called "RIFF Structure."

1.4.4 Note Exclusivity

The DLS Device has provisions for two forms of note exclusivity on a MIDI channel basis. The first form of exclusivity involves notes on a MIDI channel with the same MIDI note number. DLS Level 2 introduces the concept of a shutting down an oscillator, to give the sound developer more control over polyphony without degrading sound quality. When a note exclusive event occurs, the Volume envelope proceeds directly to the release phase, but using the time constant EG1_SHUTDOWNTIME, instead of EG1_RELEASETIME.

By default, if a MIDI Note-On event is received and there are oscillators previously assigned to the same MIDI note and MIDI channel that have not received a Note-Off event (or Note-On event with a velocity of 0), the control logic will immediately shutdown those oscillators. However, there is a flag in the *usKeyGroup* field in the region header chunk that, when set, will defeat this logic. When the *Non-Self-Exclusive* flag is set, Note-On

events for a particular MIDI note number on a MIDI channel do not cause a shutdown of oscillators assigned to the same MIDI note and MIDI channel. When the *Non-Self-Exclusive* flag is not set and a second Note-On event of the same MIDI note number on the same MIDI channel is received by the synthesis engine, the second Note-On will be played as well as the first. The *Non-Self-Exclusive* flag is off by default.

The second form of note exclusivity is useful for drums and sound effects. Each region can be assigned a *Key Group*. If a Note-On event is received and there are oscillators that have been assigned to play a region that has the same *Key Group* number as the region for the new Note-On, those oscillators are shutdown. As an example, this can be used to create mutually exclusive Open, Closed and Pedal High Hat sounds for a drum group. A second example might be in a sound effects collection to stop a squeaking door sound when the sound of the door closing is triggered.

1.4.5 Voice Allocation

Voice Allocation is the means by which digitally controlled oscillators are allocated to play samples as dictated by the instrument parameters and the MIDI data stream. Ideally, there should be enough to play every note and sound effect in the score. However, this may not always be the case. Some devices may have more oscillators than others, and the developer may choose to develop a score that uses more than the minimum amount of polyphony to take advantage of this. If the MIDI data stream calls for more oscillators than the device is capable of producing, the developer must be able to accurately predict the end result.

To satisfy this need, the device defaults to static MIDI channel priority. In this scheme, each MIDI channel is assigned a priority, with the nominal drum channel (MIDI channel 10) given the highest priority, followed by the remaining channels in ascending numeric order (10,1-9,11-16).

When a Note-On event is received, the Control Logic must first attempt to satisfy the request using a free oscillator. If all oscillators have been previously allocated, then an oscillator must be "stolen"; that is to say, the previous note is silenced, and a new note is begun. Using static MIDI channel priority, an oscillator assigned to a note on channel 16 would be stolen before one on channel 15, and so on. Notes on lower priority channels cannot steal oscillators assigned to notes on higher priority channels under any circumstances. For example, if a Note-On is received on channel 11, and all oscillators are currently assigned to notes on channels 10 and below, then the new note is not played. This logic applies even to notes in the Release phase, i.e. after a Note-Off event (or Note-On event with a velocity of 0) has been received.

The implementer is free to use any other voice allocation heuristic, provided that the channel priority heuristic is satisfied first. This flexibility allows for further prioritization within the channel, such as released notes vs. unreleased notes, "inside" versus "outside" voices, or any other scheme that the implementer cares to use.

The DLS device will be in static MIDI channel priority by default (or upon entering DLS mode if equipped for multiple modes of operation), and when it receives the DLS System On message. This static MIDI channel priority mode can also be enabled or disabled through a DLS System Exclusive message. To turn off static MIDI channel priority, a programmer would send the DLS Voice Allocation Off System Exclusive message (F0h 7Eh <device ID> 0Ah 03h F7h). As is common for this type of MIDI Message, <device ID> = 7Fh means the message is intended for all DLS devices in the system. To restore static MIDI channel priority, a programmer can send the DLS Level 1 Voice Allocation On System Exclusive message (F0h 7Eh <device ID> 0Ah 04h F7h), or reset the device with the DLS System On message. DLS Voice Allocation System Exclusive messages have no effect on a DLS device which is not currently in DLS mode. Please see the MIDI Specification for more details on System Exclusive Messages.

When static MIDI channel priority is turned off, device manufacturers may use any voice allocation heuristic, but consistent playback on any DLS Level 1 device can not be guaranteed except in static MIDI channel priority mode. Applications that modify the voice allocation mode should always return it to the default state upon exiting.

Be aware that polyphony is defined in terms of oscillators and not in terms of notes. A DLS instrument that allows multiple regions to play from a single note ("layered") will use one oscillator for each region, which will exhaust the pool of oscillators twice as fast as an instrument that is not layered.

1.4.6 Bank Select and Program Change

The DLS device must support MIDI Bank Select and Program Change messages as the method of selecting the instrument to be played on a MIDI channel. The Bank Select address space consists of 16,384 banks, represented by the MIDI Controller Change MSB and LSB Messages (controllers 0 and 32, respectively), with each bank supporting up to 128 instruments, for a total address space of over 2 million instruments.

The device does not take any direct action upon receipt of Bank Select messages, but saves the state for future reference. Upon receipt of a Program Change message, the device should refer back to the previously received Bank Select values to decode the correct instrument to be played. The Bank Select LSB and MSB are concatenated as 8-bit bytes to form *ulBank* as shown:

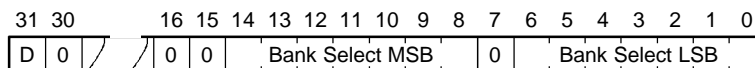

Content authors must send Bank Select MSB, Bank Select LSB and Program Change messages in that order to insure that the correct instrument is selected. Bank Selects must be included with every program change. Bit 31 indicates a drum instrument. This effectively divides the address space into drum and melodic instruments, with drums restricted to MIDI channel 10. The device should search for instruments with Bit 31 set when a Program Change is received on MIDI channel 10, and it should search for instrument with Bit 31 clear on all other channels.

1.4.7 Phase-Locked Samples

DLS Level 2 introduces phase-locked samples as a new requirement, providing a means for linking multiple samples in phase lock. This is useful for stereo samples of instruments such as pianos or drums where maintaining phase coherency of high frequencies is critical to reproduction of the stereo image. While the means for accomplishing this existed in DLS Level 1, it becomes a requirement of DLS Level 2 synthesizer to support 2-channel phase locked samples. Phase locked samples must maintain sample lock to within plus or minus one half-sample at the device sample output rate.

1.5 Digital Audio Engine

The digital audio engine consists of the Digital Oscillator, the Digitally Controlled Filter, and the Digitally Controlled Amplifier.

1.5.1 Digital Oscillator

The Digital Oscillator takes as its input an audio sample data in either 8- or 16-bit PCM format, and plays it back at a rate controlled by the articulation data. It must perform interpolation on the sample data in order to convert it from the sample rate at which it was recorded to the output sample rate, applying any pitch translation required by the articulation data.

The sample data can be 16-bit two's complement or 8-bit offset two's complement (often referred to as 8-bit unsigned data, with zero represented as 0x80). This complies with the both the RIFF WAVE PCM format and common practice on the Macintosh. To convert between offset two's and standard two's complement (signed 8 bit, -128 to +127), XOR each byte of the source sample value with 0x80.

The sample defines whether it is to be played once through or looped. If looped, the sample supports one looped region, as defined by a pair of fixed sample data point indices. The loop start specifies the first sample data point in the loop, while the loop length specifies the number of samples in the loop. There is no fractional component to the loop points.

DLS Level 1 defines the Forward Loop type as shown:

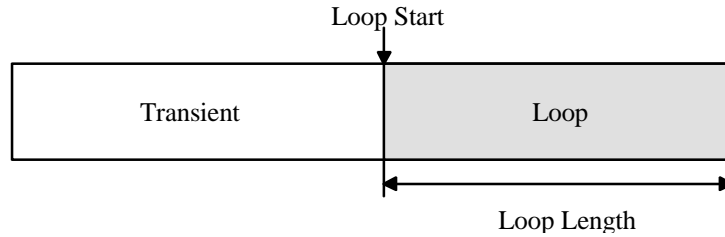

Figure 3: Forward Loop

The device begins playback at the start of the sample. Upon reaching the end of the loop as defined by the loop length, the device returns to the start of the loop. Playback continues in this fashion until the end of the release segment of the envelope.

DLS Level 2 defines a new loop type, called “Loop and Release”. In this loop, the device begins playback as in the simple loop form. However, at the time that the MIDI Note-off event is received, the device does not return to the beginning of the loop, instead playing straight to the end of the sample. It is very important that the device not jump directly to the release segment, but continue playing from wherever it may be in the loop straight through to the end of the sample, thus maintaining continuity in the samples.

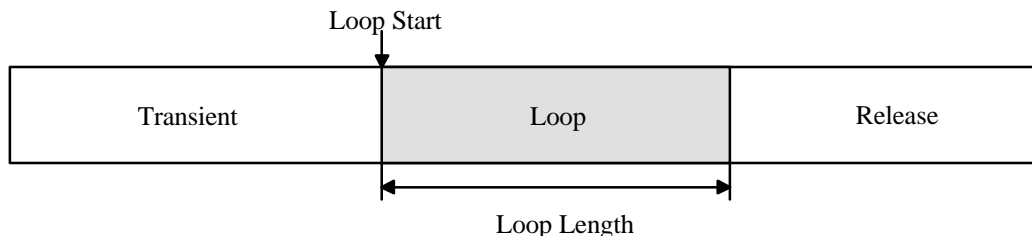

Figure 4: Loop and Release

The sample structure defines the MIDI note number, fine tune, and sample rate of the recorded sample, providing all the information required for the digital oscillator to pitch shift the sample appropriately for the intended pitch. The Digital Oscillator must be capable of pitch shifting the sample with a range of up two octaves and down four octaves. This pitch shift is the sum total of all tuning parameters, including sample fine tune and MIDI pitch bend.

1.5.2 Digitally Controlled Filter

The input to the Digitally Controlled Filter is the audio data stream produced by the Digital Oscillator. The input samples contained in the audio data stream are then filtered as required by the articulation data. The filter is defined to be a 12 dB/octave cutoff slope lowpass digital filter with a transfer function of the form:

$$H(z) = \frac{K}{1 + b_1 z^{-1} + b_2 z^{-2}}$$

This transfer function represents a single complex pole pair located within the unit circle at radius r and angle θ where:

$$\begin{aligned} b_1 &= -2 r \cos\theta \\ b_2 &= r^2 \\ K &= g (1 + b_1 + b_2) \end{aligned}$$

where g is a gain factor which depends on the intended resonance. This is done in order to keep the perceived loudness approximately constant. Otherwise, the addition of resonance will make the sound louder. As the resonance is increased, g is decreased as follows:

$$g = 10^{-\text{resonance}/40}$$

where the resonance is expressed in decibels. Another way to look at this is that the DC gain of the filter is attenuated by a factor equal to half the decibels of the resonance value. When g is expressed in decibels, the relationship between g and resonance is:

$$g_{dB} = \frac{-\text{resonance}}{2}$$

For example, if the specified resonance is 20 dB , g_{dB} is -10 dB . Since g is multiplicative to the numerator of the transfer function, it is equivalent to apply it after the filter by summing g with the other gain sources for the signal. However, it is desirable to perform this within the filter when bit-width becomes a limiting factor to headroom within the filter delay memory.

Such filters can either express a non-resonant lowpass filter with a frequency response similar to:

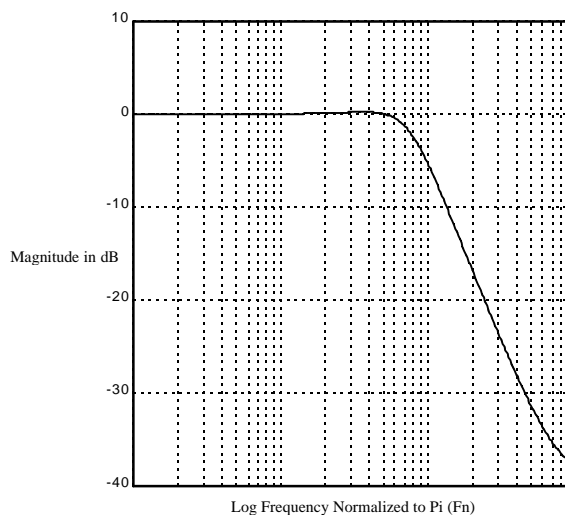

Figure 5: Low Pass Filter

or a filter with a marked resonant peak with a response similar to:

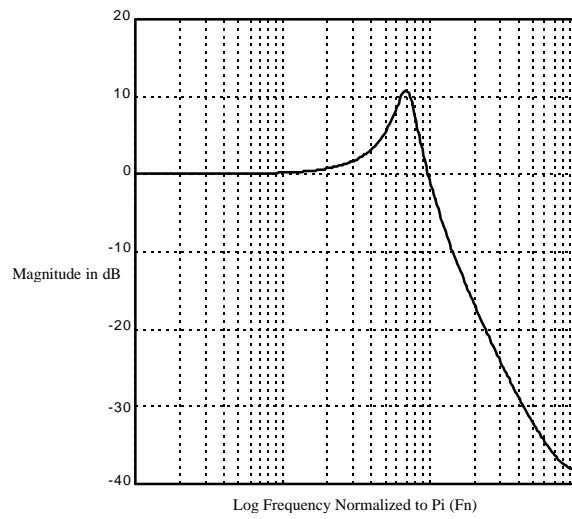

Figure 6: Filter Resonance

The filter will be characterized by a **resonance** specified in 32-bit gain units ($dB/655360$), which will represent the ratio of the gain at DC to the gain at the top of the resonant peak. A filter with a specified resonance of 0 will not have any resonant peak. It is illegal to specify a negative gain value for resonance. The default resonance value is 0.

■

Figure 7: Filter Cutoff Frequency

The filter will be characterized by a cutoff frequency in 32-bit absolute pitch units. This frequency is the frequency of the point of intersection of the DC gain line of the filter (a horizontal line on the frequency response) with the asymptotic cutoff line of the filter (a downward sloping line at 12 dB/octave). Because of the deviation from asymptotic behavior near the Nyquist frequency, this asymptotic cutoff line will be the line drawn at -12 dB/octave passing through the point one octave below the Nyquist frequency on the filter frequency response. This method is used rather than the standard -3 dB point because this makes the filter cutoff frequency less sensitive to the height of the resonant peak. Note that in most cases, when calculated in this manner, the difference between the cutoff frequency and the center frequency of the resonant peak (when resonance is present) is very small. A generalized line in gain-frequency space at -12 dB/octave is defined by the following equation:

$$h_{-12dB} = Af^{-2}$$

In order to find the line that intersects the filter response curve at the Nyquist/2, one must solve for A:

$$A = \frac{F_s^2 h_{filter}(F_s/4)}{16}$$

where F_s ≡ sample frequency and $h_{filter}(F_s/4)$ is the gain of the filter at the Nyquist/2. The filter cutoff frequency is the intersection of that line and the DC gain of the filter:

$$F_c = \frac{F_s}{4} \left(\frac{\sqrt{1 - 2r \cos \mathbf{q} + r^2}}{\sqrt[4]{1 + 2r^2 \cos(2\mathbf{q}) + r^4}} \right)$$

So, \mathbf{q} can thus be expressed as a function of F_c and r :

$$\mathbf{q} = \arccos \left(\frac{-F_s^4(r^2 + 1) + 16F_c^2 \sqrt{2F_s^4(r^4 + 1) - 256F_c^4(r^2 - 1)^2}}{2r(256F_c^4 - F_s^4)} \right)$$

The resonance of the filter is given by the following expression:

$$resonance = 20 \log_{10} \left(\frac{1 - 2r \cos \mathbf{q} + r^2}{(1 - r^2) \sin \mathbf{q}} \right)$$

where r and \mathbf{q} are the radius and angle of the poles of the filter. Note that this is decibels, not absolute gain units. Given this relationship, the radius can be calculated as a function of resonance and θ as shown in the following equation:

$$r = \frac{\cos \mathbf{q} + \sin \mathbf{q} \sqrt{10^{resonance/10} - 1}}{10^{resonance/20} \sin \mathbf{q} + 1}$$

where resonance is specified in decibels. The derivation of these equations is left as an algebraic exercise for the reader.

1.5.3 Digitally Controlled Amplifier

The final module in the signal path is the digitally controlled amplifier (DCA). It modulates the amplitude of the of the digital oscillator signal, responding to controls from the articulation section, of which the amplitude envelope is probably the most important.

For the purposes of this document, the maximum output of the DCA is assumed to be 0 *dB* or unity gain, though as a practical matter, some attenuation may be required prior to summing all the oscillator outputs together to form the final synthesizer output. Therefore, all changes in the DCA are measured in *dB* units of gain from the 0 *dB* reference point, and all units of *dB* in this document refer to voltage, rather than power. Positive units of gain represent an increase in output voltage, and negative units represent a decrease in output voltage. The MIDI pan signal is fed through a transform that converts to left and right amplitude signals. These signals are fed separately into the DCA to generate stereo output from the monophonic signal entering the DCA.

The gain of the DCA can be varied dynamically through the use of modulators. Since the steps in the input sources can be rather severe, the designer must ensure that audible artifacts, such as "zipper" noise, are minimized by filtering the control source. This can be accomplished by interpolating between control events such as MIDI controller sources.

1.6 Articulation Modules and Connections

The Articulation modules include two low frequency oscillators (LFOs), two envelope generators, and a number of MIDI controller inputs. A configuration is defined by connecting this base set of modules and setting the controls for each one.

1.6.1 Signal Flow

The Control Logic module translates MIDI note and sustain events into region/sample choice and associated control signals, including Key (the note number), Velocity (note emphasis), and Gate. Gate defines the start and end times of the note, and is used to trigger modulators, such as the LFO and envelope generators. Gate is also used to control the loop status in the digital oscillator for Loop and Release samples.

The digital oscillator unit plays the sample. It is primarily controlled by the Pitch Sum node, which accumulates signals from modulation sources to deliver the final pitch for the instrument.

The output samples of the digital oscillator flow into the digital filter. The cutoff frequency and the resonance characterize the operation of the filter.

The digitally controlled amplifier takes the output samples of the digital filter. It is controlled by two signals: the Volume Sum node, which accumulates signals from modulation sources to deliver the final volume of the instrument; and the MIDI pan signal, which sets the stereo position of the stereo digital output.

Control signals from MIDI modulation sources, such as Volume and Pitch Bend, flow through connections which use their gain values and transforms to define the range of the control. The Volume Sum node (DST_GAIN) can be viewed as a summing node if signals are represented in *dB*, or as a multiplier if signals are represented in linear units. 0 *dB* is defined as the maximum output level at the Volume summing node (DST_GAIN).

1.6.2 Connection Block

Each connection can be viewed as a block that defines the *usSource*, *lScale*, *usControl*, optional *usTransform*, and *usDestination*.

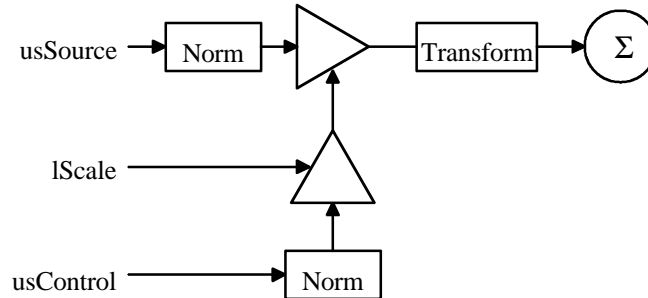

Figure 8: Connection Block

Each external source goes through a normalization block that scales and applies certain types of transforms to the signal. Further transforms may be applied at a later stage. The normalization block scales the incoming values to a range of -1 to +1 for a bipolar transfer function, or 0 to 1 for unipolar transforms. The output of the transform may also be inverted at this stage.

All connections to a single destination are summed together to produce the final input for that destination. The pseudo-code for a connection block is as follows:

```
usDestination = usDestination + usTransform(Norm(usSource) *
      (Norm(usControl) * lScale))
```

Controlled Scaled Source connection blocks use the *usControl* input to modulate or control the scaled *usSource* input routed to the *usDestination*. A Controlled Scaled Source connection consists of *usDestination*, *lScale*, *usSource*, *usControl* and an optional *usTransform*. The result is a signal that is modulated by both the *usSource* input and the *usControl* input. An example of this is the LFO Mod Wheel to Pitch connection block, which allows the Modulation controller (CC1) to determine the amount of LFO output applied to *usDestination* DST_PITCH, which is the frequency of the digital oscillator.

Any unconnected inputs are seen as a full scale signal, so that the output of the normalization block is either +1 (for non-inverted signals) or -1 (for inverted signals). With no input connected to *usControl*, the connection block takes on the simpler form of a Scaled Source, where *lScale* sets the amount of modulation that flows from the source input to the destination.

Scaled Source connection blocks scale the *usSource* input routed to *usDestination*. A Source Scale connection block consists of *usDestination*, *lScale*, *usSource*, and an optional *usTransform*. The *usControl* input is set to SRC_NONE. The result is a signal that is modulated by the *usSource* input and applied to the *usDestination*. An example of this is the EG2 to Pitch connection block, the amount of modulation applied to pitch from the Pitch Envelope to *usDestination* DST_PITCH.

With no input on either *usSource* or *usControl*, the connection block takes on the simplest form of a Scaled Connection, which is a bias applied to the destination. As examples, Scaled Connections are used to alter the playback frequency, to set the initial gain of the digital amplifier, or to set the initial cutoff frequency or resonance of the filter.

1.6.3 Default, Global and Local Articulation Data

The DLS specification defines default connections for both Level 1 and Level 2 devices, which determines the behavior of the instrument in the absence of specific articulation data. An important concept of DLS is that each combination of *usSource*, *usControl* and *usDestination* defines a unique connection for that region. In the absence of articulation data for a specific connection, the default values for that connection will be used. If the articulation data contains such a connection, it takes precedence over the default values *for that connection only*. Duplicate connections within a single region are not allowed, and the behavior of the device is undefined under those circumstances. *Note that DLS Level 2 devices do not give any preference to <art2-ck> chunks over <art1-ck> chunks, they are treated identically.*

For example, if a region contains an <art1-ck> chunk and an <art2-ck> chunk, and the EG1 Release Time is set to different values in the two articulation chunks, the actual release time is indeterminate for DLS Level 2 devices. To avoid this condition, the <art1-ck> should be guarded by a <cdl-ck> conditional chunk which excludes devices that support DLS Level 2. This will cause the DLS Level 2 device to ignore the <art1-ck> and read only the <art2-ck>.

Global articulation data defines the behavior of any regions that do not have applicable local articulation data, either because the local articulation data does not exist, or the device fails to meet the conditional criteria. In the event that no applicable local articulation data exists, the instrument behavior for that region is defined by the global articulation data. If local articulation data does exist that meets the conditional criteria of the device, the local data will override all global articulation data. In other words, global articulation data, and its implied default connections, must be treated as a monolithic block of data: used as a whole; or discarded in favor of local articulation data. This is in contrast to default articulation data, which is overridden on a connection by connection basis, both at the global and local level. This is an important distinction to understand and forms the basis for the parsing code.

1.6.4 Controller Theory

All control signals in the DLS synthesizer model are normalized to a range from -1 to 1. They may also go through an optional series of input transforms. Internal sources are assumed to generate their outputs already normalized.

The following equations all assume that the controller input signal "*Input*" and the controller range "*Range*" are positive. For example, MIDI controllers are assumed to have input values from 0 to 127 with a range of 128, while the pitch bend controller is assumed to have input values from 0 to 16,383 with a range of 16,384. For example, the formula for normalizing the Modulation controller CC1 for linear, unipolar output is as follows:

$$\text{Output} = \text{CC1} / 128$$

Another example, normalizing the Pitch Wheel for bipolar linear output is as follows:

$$\text{Output} = 2 * \text{PitchWheel} / 16384 - 1$$

1.6.5 Transforms

In many cases, the input data to a module must be transformed into units that can be accepted by that module. For example, the linear output of an envelope generator needs to be converted into a format compatible with the DCA, typically an exponential transform. Likewise, the link between a MIDI volume input and the DCA must undergo a similar transform. To accomplish this, the connection mechanism allows for an optional transform to be defined for every connection. Only the transforms specified in the Default Routing Modulation Table are required for DLS Level 2 Synthesizers, thus all the specified connections are fixed. However, different routing is allowed within articulation list chunks that are marked with proprietary conditional chunks to allow manufacturers to support specific features in their own DLS Level 2 devices.

1.6.5.1 Invert

The Invert flag inverts the polarity of the controller signal when set. For MIDI controllers, this operation must be performed before the controller input is normalized, in order to reflect the asymmetry of the MIDI controllers.

The algorithm is straightforward:

```
if (invertFlag)
    input = MaxValue - input;
```

1.6.5.2 Bipolar

The Bipolar flag maps the controller input signal to a range of -1 to +1. For non-linear input transforms, this introduces a slight complication, as the non-linearity must be mirrored in both the positive and negative quadrants. The following algorithm performs this mapping when the bipolar bit is set:

```
if (bipolarFlag)
{
    value = 2 * input / Range - 1;
    output = sgn(value) * InputTransform(abs(value));
}
else
    output = InputTransform(input);
```

1.6.5.3 Input Transforms

The Input Transform maps all controller signals to a range of 0 to 1. The various transforms and their associated equations are as follows:

Linear: Input values map linearly as defined by the following equation:

$$Output = Input / Range$$

Concave: Input values are mapped in a concave fashion as defined by the following equation:

$$\text{For } Input = Range, Output = 1$$

$$\text{For } Input < Range, Output = 5 / 12 \log_{10} (Range / (Range - Input))$$

Convex: Input values are mapped in a convex fashion as defined by the following equation:

$$\text{For } Input = 0, Output = 0$$

$$\text{For } Input > 0, Output = 5 / 12 \log_{10} (Range / Input)$$

Switch: Input values are mapped to either zero or one as follows:

$$\text{For } Input \text{ values } < Range / 2, Output = 0$$

$$\text{For } Input \text{ values } \geq Range / 2, Output = 1$$

The diagrams in Figure 9 show all four transforms possible with the Linear transformation, as well as unipolar and bipolar transforms for the other types of currently defined Input Transforms. The inverted forms of the other transforms are not shown.

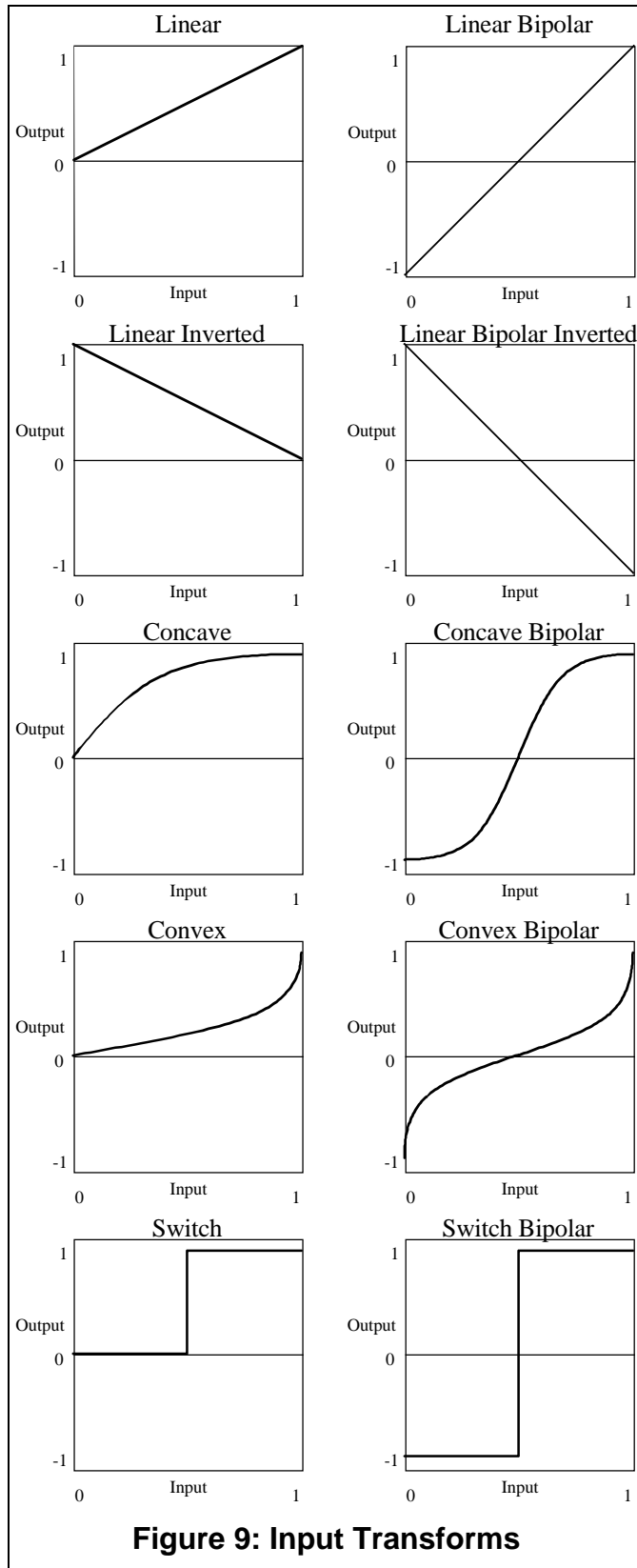

Figure 9: Input Transforms

1.6.5.4 History of the Concave Transform

The Concave Transform was created to maintain compatibility with existing General MIDI implementations. Its name comes from the shape of the curve when graphed as a linear volume output. In DLS Level 1, it was defined as a series of fixed connections from MIDI controllers 7 and 11, and velocity, to attenuation in *dB* using the following formula:

$$atten_{dB} = 20 \times \log_{10}(127^2 / Input^2)$$

To map this fixed transform onto the flexible routing model found in DLS Level 2, it is necessary to adjust the output of the transform so that it produces the desired curve in the range 0 to 1, such that when scaled at 96 *dB* and applied to the DST_GAIN summing node, it produces the same output curve as that of the DLS Level 1 and GM devices.

1.6.5.5 Output Transforms

There are no output transforms defined in the DLS Level 2. The bits in the output transform field must all be set to zero for compatibility with future versions of DLS.

1.7 Generators

Each oscillator has two low frequency oscillator generators and two envelope generators. Each generator has a set of controls to determine its behavior.

1.7.1 Low Frequency Oscillator

The LFO generates a periodic waveform that is used to modulate the pitch or volume of the instrument. The LFO waveform may be either a triangle or sine wave.

1.7.1.1 Frequency

The frequency control sets the wave frequency between 0.1 Hz and 20 Hz in absolute Pitch Cents.

1.7.1.2 Start Delay Time

The LFO starts after a preset delay time from 10 milliseconds to 10 seconds in Time Cents. The device is not allowed to produce any artifacts when the LFO starts after a delay. If the device cannot synchronize the LFO phase to the end of the delay cycle, it is recommended that the LFO output be ramped up to full scale over a one cycle period to eliminate the possibility of introducing a DC offset into the output path.

1.7.2 Envelope Generator

The envelope generator creates a six-segment envelope. The segments correspond to the attack, decay, sustain, and release phases of the traditional analog ADSR (Attack, Decay, Sustain, Release) design, plus two new phases: Delay and Hold. The following diagram shows the relationship between the various envelope phases and the output levels.

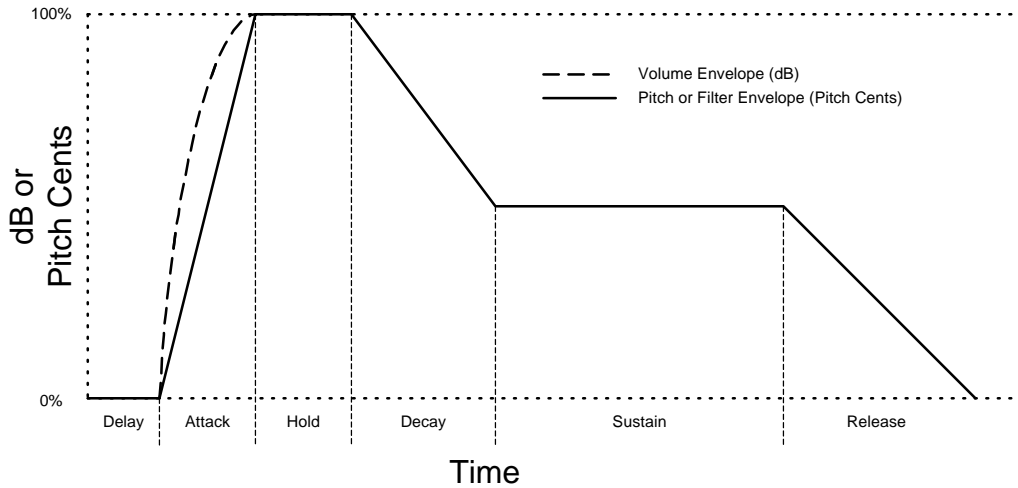

Figure 10: Envelope

Upon receiving a Note-On event, the envelope enters the Delay phase, and the output of the envelope generator remains at zero throughout this phase. At the completion of the Delay phase, the envelope generator begins the Attack phase, where it transitions from zero to full scale in linear fashion. After the Attack phase, the generator enters the Hold phase, where the output holds at full scale for the specified time. After the Hold phase, the generator enters the Decay phase, where it falls to the Sustain Level in an exponential decay fashion.

Upon reaching the Sustain Level, the generator remains at this level until a Note-Off event (or a Note-On event with a velocity of 0) is received. Upon receiving a Note-Off event, and regardless of the previous state, the generator enters the Release phase, with the output falling in an exponential fashion from its current level until it reaches the pre-determined zero level again (typically -96 dB).

Decay and Release Time Constants are actually rates defined as the time for the signal to decay from full scale to -96 dB , at which point it is assumed that most implementations will make an abrupt transition to infinite attenuation.

IMPORTANT: The following envelope diagrams show all envelope segments with linear slopes. The Decay and Release segments are actually exponential decay functions, but are shown linear in these diagrams as a simplification.

1.7.2.1 EG Delay Time

The delay time determines the amount of time in Time Cents from Note-On until the Attack segment begins. Nominally, this time will be set to zero so that no delay in the envelope occurs. If it is not zero, then the envelope generator should hold its output to zero for the specified delay time, then begin the attack segment. Note that the digital oscillator still begins playing the sample at the time the Note-On is received, so this only has the effect of cutting off the start of the sample.

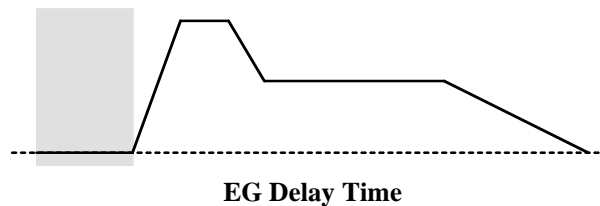

1.7.2.2 EG Attack Time

The attack time determines how long the attack segment lasts from the end of the Delay Time until the envelope hits peak level. When the output of the envelope is applied to gain, the Attack segment affects the output of the oscillator in a linear fashion with respect to amplitude. This requires a slightly more complex coupling to the DCA, since the envelope output will undergo a different transform during the attack segment than during all other segments.

When the envelope output is applied to any other destination, the effect is linear with respect to the units used at that particular destination. For example, when applied to pitch, the envelope will always affect the pitch of the oscillator in a linear fashion with respect to units in Pitch Cents, which is exponential with regard to frequency. The filter cutoff F_c will likewise be affected in a linear fashion with respect to Pitch Cents, or exponential with regard to frequency.

If the attack time is set to zero, the envelope generator should immediately go to peak output. Likewise, any controls to which the envelope is routed should also go to full output. For example, if the attack time of the Volume EG is set to zero, the amplitude of the DCA at the time the first sample is output must be at full scale so that any transients in the sample are faithfully reproduced.

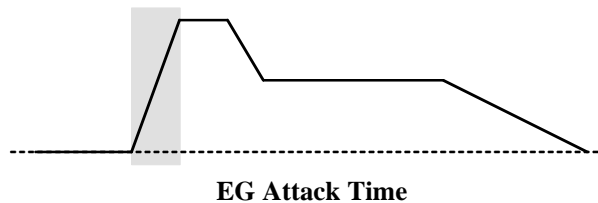

1.7.2.3 EG Velocity to Attack Scaling

The MIDI velocity scales the duration of the attack segment. Since all times are described in Time Cents, which are logarithmic units, the effect of adding values in Time Cents is multiplicative in actual time. The formula is as follows:

$$Attack_Time_{timecents} = Nominal_Attack_Time_{timecents} + (Velocity / 128) * Attack_Scalar_{timecents}$$

Where *Nominal_Attack_Time* is the attack time constant set by the articulation data, *Velocity* is the MIDI Note-On velocity, and *Attack_Scalar* is the IScale value from the EG Velocity to Attack Time connection.

1.7.2.4 EG Hold Time

After the attack phase, the envelope generator enters the optional Hold phase. If the Hold Time is set to zero, then the generator should proceed directly to the Decay Phase. If the Hold Time is not zero, the generator must hold the generator output level at full scale for the specified time. The Hold Time is specified in Time Cents.

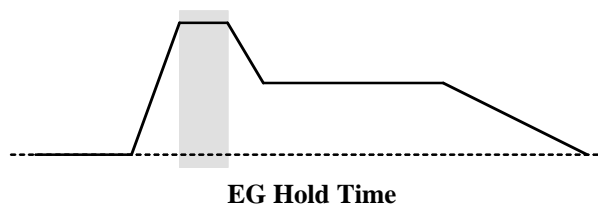

1.7.2.5 EG Decay Time

The decay time determines the duration of the decay segment. Because the decay segment is an exponential decay function, it is not possible to express the decay function purely in terms of time. Instead, Decay Time is expressed as the amount of time it takes for the signal to decay from full scale to -96 dB in Time Cents.

Since the Sustain Level sets the end point of the Decay segment, the exact duration of the Decay segment will be determined both by the Decay Time, and the Sustain Level. In effect, the Decay Time can be thought of as setting the inverse of the decay rate, as opposed to an absolute time. The dashed line in the following figure indicates how the Decay Time value is actually determined.

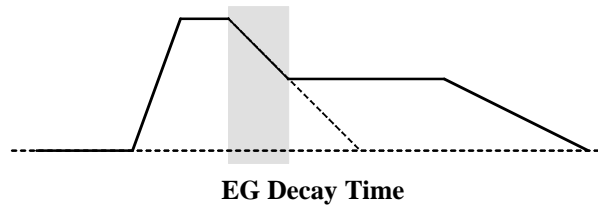

1.7.2.6 Decay Scaling

The MIDI note number scales the duration of the decay segment. For example, increasing the note number could decrease the duration of the decay, just as a piano note decays slower for lower notes and faster for higher notes. The formula is as follows:

$$Decay_Time_{timecents} = Nominal_Decay_Time_{timecents} + (Note_Number / 128) * Decay_Scalar_{timecents}$$

Where *Nominal_Decay_Time* is the decay time constant set by the articulation data, *Note_Number* is the MIDI note number, and *Decay_Scalar* is the IScale value from the Mod EG Note to Decay connection.

1.7.2.7 EG Sustain Level

The Decay segment ends when the Sustain Level is reached and the note sustains at this level until the Note-Off event (or Note-On event with a velocity of 0) is received. Raising the Sustain Level will shorten the Decay segment and lengthen the Release segment, while lowering it will have the opposite effect. Sustain is defined as a percentage of the envelope peak in 0.1% increments. Note that Sustain Level is in ordinal units, the actual range is determined by the *IScale* setting of the connection and the unit type is determined by the units used by the destination node. Thus the sustain level as applied to CONN_DST_GAIN is in Gain units (dB), and similarly when applied to CONN_DST_PITCH or CONN_DST_FILTER_CUTOFF is in Pitch Cents.

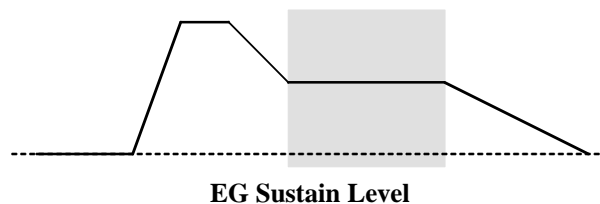

1.7.2.8 EG Release Time

The release time constant determines the duration of the release segment. Like the Decay time, the Release segment is an exponential decay measured as the time it takes to decay from full scale to -96 dB . Just as with the Decay segment, the actual time is dependent on the Sustain Level, or in the case of a Note-Off (or Note-On with a velocity of 0) before the Sustain Level is reached, then the actual time is dependent on the level at the time the Note-Off (or Note-On with a velocity of 0) is received.

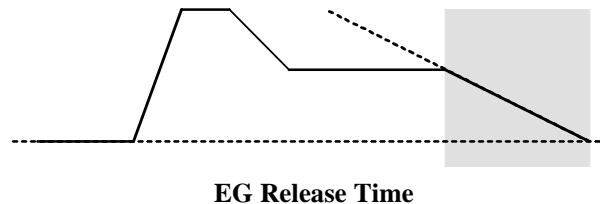

1.7.2.9 EG Shutdown Time

The shutdown time constant determines the duration of the release segment when a note-exclusive or key-exclusive event occurs. It behaves identically to the EG Release Time constant, but is only invoked when an exclusive event causes the shutdown of an oscillator.

1.7.3 Key Number Generator

The Key Number Generator provides a mechanism for modifying the region selection process. It exists in DLS Level 2 primarily as a means to accommodate the behavior of the RPN2 Coarse Tuning Parameter. The function is fixed and this connection should not appear in a DLS Level 1 or Level 2 file except in a proprietary conditional chunk. Because the Key Number generator affects region selection, input connections to the Key Number Generator are only valid at the global articulation level in the instrument LIST chunk.

The Key Number Generator has a single input `DST_KEYNUMBER` and a single output `SRC_KEYNUMBER`. The default input connections route the MIDI note number and RPN2 to `DST_KEYNUMBER`, allowing for modification of region selection.

The default output connection routes the Key Number Generator to Pitch. There is an implied connection from the output of the Key Number Generator to the control input that selects the correct region. The Key Number to Pitch output connection is allowed at both global and local articulation levels.

1.8 Performance Controllers

MIDI Controllers can be used to modify synthesis parameters in real-time to add depth to a performance. The following MIDI controllers are supported:

1.8.1 Note Number

The MIDI Note Number normally determines the playback frequency of the instrument. The default connection is to map an Equal Temperament 12-tone (ET-12) scale to the keyboard, such that the difference between each key is an ET-12 semitone. However, it is sometimes useful to change the default key scaling so that the pitch does not change across the keyboard. The DLS Device architecture allows the Note Number to Pitch connection to be specified with a *IScale* of zero, which means that the Note Number will have no effect on the pitch. Other values may be used for *IScale* to modify the tuning for quarter-tones or other useful increments.

1.8.2 Volume

MIDI Volume Controller events (MIDI Controller 7) are connected by default to the DST_GAIN summing node to modify the output volume, and are mapped through the Concave Transform.

1.8.3 Expression

MIDI Expression Controller events (MIDI Controller 11) are connected by default to the DST_GAIN summing node to modify the output volume, and are mapped through the Concave Transform.

1.8.4 Velocity

MIDI Note-on Velocity is connected by default to the DST_GAIN summing node to modify the output volume and is mapped through the Concave Transform. The connection may be scaled as either -96 dB , which matches the curve of a typical GM device and is the default setting, or 0 dB , which means that Velocity has no effect on the output. The latter is used to simulate organs, harpsichords, and other instruments that do not respond to velocity.

1.8.5 Pan

After normalization, the MIDI Pan event (MIDI Controller 10) is nominally fed directly to the digitally controlled amplifier where it is used to set the pan position in the stereo field. An equal power equation is used to define the distribution from left to right. DST_PAN is the destination for pan control sources, and is measured in percentage units with a minimum value of -50% and a maximum value of 50% . After all inputs to DST_PAN have been summed, the value should be limited to the range $\pm 50\%$. The equation for individual channel gain in dB is given by the following formula:

$$\text{Left Channel Gain}_{\text{dB}} = 20 \log_{10} (\cos (\pi / 2 * (\text{DST_PAN} + 50\%)))$$

$$\text{Right Channel Gain}_{\text{dB}} = 20 \log_{10} (\sin (\pi / 2 * (\text{DST_PAN} + 50\%)))$$

Note that for values of -50% and 50% , one of the two stereo channels will have a gain of negative infinity, meaning that channel should be fully attenuated, while the other will have a gain of 0 dB . The following is a graph of the left and right channel outputs plotted against values of the DST_PAN node:

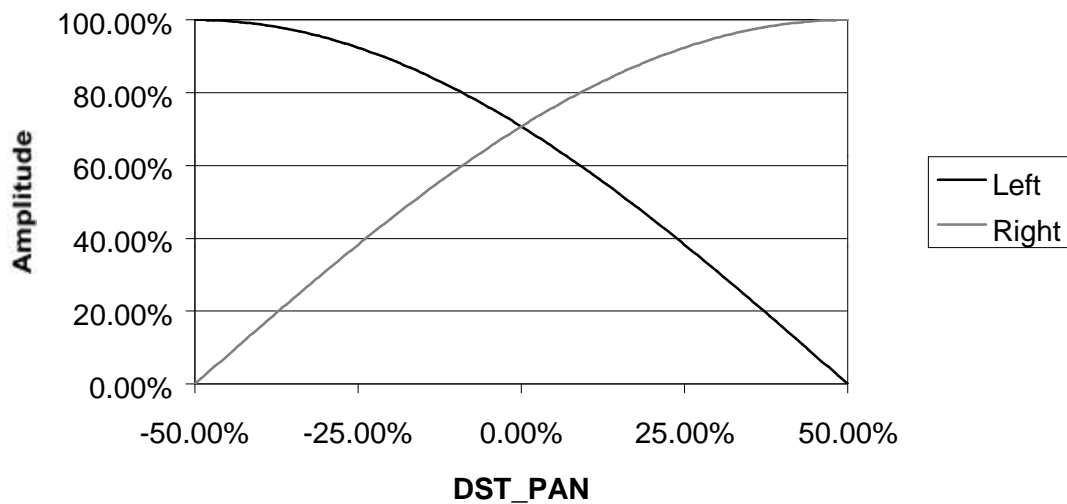

Figure 11: Pan Curve

The DLS Level 2 device must support active panning of a signal within the stereo field without sound artifacts, which will require smoothing filters to the DCA inputs to prevent zipper noise in most implementations. The exact form of these filters is up to the implementer, however there must be no perceptible control lag in the response to MIDI Controller 10 events.

Due to asymmetry in the MIDI controllers, it is impossible to pan a sound to full right unless the *lScale* value applied to DST_PAN is larger than 50%. For this reason, the default connection from CC10 to DST_PAN is 50.8%. When the value of CC10 is 64 the sound will be placed exactly in the center, while values of 0 or 1 will attenuate the right channel completely and a value of 127 will attenuate the left channel completely.

COMPATIBILITY NOTE: DLS Level 1 used a different set of equations for distributing signal between stereo channels. Both the DLS Level 1 and Level 2 equations result in equal power throughout the range, meaning that the perceived volume of the sound source will not change with respect to the pan position. However, there will be some subtle differences in the perceived stereo effect with respect to the two curves, particularly as sound sources are panned to the extreme ends of the range. It is acceptable for DLS Level 1 devices to continue to use the DLS Level 1 equations, however all DLS Level 2 devices must adhere to the new equations.

1.8.6 MIDI Controller 1 (Modulation)

The Modulation controller (CC1) may be used to set LFO depth, with separate level assignments for LFO pitch modulation, LFO volume modulation, or filter cutoff frequency modulation.

1.8.7 Channel Pressure

Channel Pressure may be used to set LFO depth, with separate level assignments for LFO pitch modulation, LFO volume modulation, or filter cutoff frequency modulation.

1.8.8 Pitch Bend

The MIDI Pitch Bend event is routed directly to the pitch summing node, and scaled by RPN 0. Registered Parameter Number data entry can be used to set the pitch range.

1.8.9 MIDI Controller 64 (Sustain)

Sustain Pedal MIDI events (MIDI Controller 64) go directly to the control logic, which uses them in conjunction with note on and off events to determine which notes are on.

1.8.10 MIDI Controller 91 (Reverb)

MIDI Controller 91 events are routed by default to the Reverb effects sends. This determines the amplitude of signal fed to the reverb effects unit. Note that the units for DST_REVERB are in percentage of amplitude, not in *dB* units.

1.8.11 MIDI Controller 93 (Chorus)

MIDI Controller 93 events are routed by default to the Chorus effects sends. This determines the amplitude of signal fed to the chorus effects unit. Note that the units for DST_CHORUS are in percentage of amplitude, not in *dB* units.

1.8.12 Registered Parameter Numbers (RPN)

Registered Parameter Numbers (RPNs) for remote data entry are supported, as per the General MIDI specification. The parameters include Fine Tune, Pitch Bend Range, and Coarse Tuning.

1.8.12.1 RPN 0 (Pitch Bend Range)

RPN0 (Pitch Bend Range) is used to alter the range of the pitch bend wheel. The DLS Device must support a maximum pitch bend range of at least +/- 12 semitones.

1.8.12.2 RPN 1 (Fine Tuning)

RPN1 (Fine Tuning) is used to alter the pitch in fine increments of less than a semitone. The control operates in 1/8192 semitone increments and has a range of -8192/8192 to +8191/8192. The DLS Device must have a minimum resolution of 1 cent (1/100th of a semitone) with accuracy of no less than plus or minus 1/2 cent. The default setting is 0, which does not alter the pitch.

1.8.12.3 RPN 2 (Coarse Tuning)

RPN2 (Coarse Tuning) is used to transpose by semitones. Coarse Tuning alters the MIDI note number before the articulation data, region, and sample selections are made by the Control Logic. This placement prevents unwanted timbre shifts in instruments that have been multisampled. The default setting is 0, which does not alter the pitch.

To accomplish this, the MIDI note number and RPN2 controller inputs are summed together in a block called the Key Number Generator. The output of the Key Number Generator is used to drive the region selection logic as well as set the base frequency of the oscillator prior to any modulations.

1.8.13 Registered Parameter Number Data Entry

The DLS Device is required to support the Data Entry MSB and Data Entry LSB Controllers (MIDI Controllers 6 and 38, respectively), but is not required to support the Data Increment and Data Decrement Controllers (MIDI Controllers 96 and 97, respectively).

The following protocol should be used to set RPN values, where *n* is the MIDI channel number, *ww* is the RPN MSB, *xx* is the RPN LSB, *yy* is the Data MSB, and *zz* is the Data LSB (all values are in hexadecimal).

```

Bn 65 ww    // Send RPN MSB
Bn 64 xx    // Send RPN LSB
Bn 06 yy    // Send RPN Data MSB
Bn 26 zz    // Send RPN Data LSB
Bn 65 7F    // Clear RPN MSB
Bn 64 7F    // Clear RPN LSB
    
```

The last two messages set the RPN to an invalid parameter number, thus preventing an inadvertent change to an RPN value by a subsequent RPN Data MSB or LSB message. If a number of RPN values need to be set, the messages to clear the RPN MSB and LSB may be left to the end of the sequence of messages to reduce the overhead. Note that only the first “Bn” status byte is necessary due to running status, but all are shown here for clarity.

1.9 Channel Mode Messages

The DLS Device must also support the following Channel Mode messages:

1.9.1 Reset All Controllers (MIDI Controller 121)

The Reset All Controllers message makes use of the data byte to allow for multiple levels of functionality. There are currently two data byte values defined. When the data byte is 0, the device will reset all controllers to their default values except the following controllers:

- Volume (Controller 7)
- Expression (Controller 11)
- Pan Control (Controller 10)

When the data byte is 127, the device will reset all controllers to their power-on default values (see Section 1.11 below). This should include all MIDI controllers and RPNs. It is left to the discretion of the device designer whether to reset any NRPNs used by the device. However, the behavior must be documented.

1.9.2 All Notes Off (MIDI Controller 123)

This message performs a Note-Off event for all notes on the specified MIDI channel. If the Sustain Pedal (MIDI Controller 64) is active, the notes should continue to sustain until a Sustain Pedal release event is sent.

1.9.3 All Sound Off (MIDI Controller 120)

The DLS Level 2 device must respond to an All Sound Off message by silencing all notes current sounding on the specified MIDI channel. Upon receiving the message, all notes should be turned off, and the output set to zero as quickly as possible. Envelopes may be ramped to prevent clicks or pops in the output. This is a panic message, and intended to be used under user control to silence the device in adverse situations. It is not a replacement for sending individual Note-Off events.

1.9.4 Other Channel Mode Messages

It is not required that the DLS device support the Omni Off, Omni On, Mono On, and Poly On messages, which are MIDI Controller numbers 124 through 127 respectively. If a device does not respond to any of these messages, it should treat them as All Notes Off messages. In all cases, the device response must be documented.

1.10 Active Sensing (0xFE)

The DLS Level 2 device is required to respond to Active Sensing messages. Specifically, the device must be able to sense the onset of Active Sensing bytes, and must turn off all voices as in the All Sound Off message when it fails to receive a message within the specified timeout period. Refer to the MIDI 1.0 Specification for more detail on Active Sensing.

1.11 Power-on Default Values

The device must reset the following control values during power-on, upon receiving the DLS Device On message (either Level 1 or Level 2), and when a Reset All Controllers message is received with data byte 127.

- | | |
|---|---------------------------------------|
| • Volume (default = 100) | • Expression (default = 127) |
| • Pan Control (default = 64) | • Modulation (default = 0) |
| • Pitch Bend (default = 0, no pitch change) | • Sustain Pedal (default = 0) |
| • CC100 RPN LSB (default = 127) | • CC101 RPN MSB (default = 127) |
| • CC91 Reverb Send (default = 40) | • CC93 Chorus Send (default = 0) |
| • Channel Pressure (default = 0) | • RPN0 Pitch Bend Range (default = 2) |
| • RPN1 Fine Tuning (default = 0) | • RPN2 Coarse Tuning (default = 0) |

1.12 Articulation Architecture

This section defines the set of modules that must be supported and it itemizes a list of required connections between the nodes of these modules. These connections define the flow of signals between modules and ultimately to the digital oscillator, DCF, and DCA to control the pitch and volume of a note as it plays.

1.13 Modulation Routing

The DLS Level 2 synthesizer supports the connection blocks listed in Table 1. Each connection lists the *usSource*, *usControl*, *usDestination*, and associated input transforms. The output transform for each of these connections is always TRN_NONE.

The articulation configuration is designed to expand into future specification levels in two ways. First, each module defines a base level set of controls and connectors. Most modules will expand as more controls and connections are added in the future. Secondly, the number of connection blocks will also grow as more articulation modules, control inputs, and required connections are added.

1.13.1 Default Connections

Certain default connections are assumed in the absence of specific data in the instrument. These default connections help reduce the amount of data required to define an instrument, because the default values are generally usable. They also facilitate the development of new instruments, because in the absence of any other articulation data, the default values will produce sound at the expected musical pitch. The sound developer may then further refine the instrument from the default values to suit his or her taste. Table 2 shows the Minimum, Maximum and Unit values for each connection block of the DLS synthesis architecture.

TABLE 1: MODULATION ROUTING

This table contains all the legal connections for a DLS Level 2 Synthesizer with fixed routing architecture. The "B" column indicates whether the particular source connection is Bipolar, and the "I" column indicates whether it is Inverted (these are the Bipolar and Invert bits in the Connection Block)

(*) To improve readability of this table, the "CONN_" prefix has been omitted from these columns.

Articulator Name	UsSource (*)	B	I	Transform	UsControl (*)	B	I	Transform	UsDestination (*)
Modulator LFO									
Mod LFO Frequency	SRC_NONE	F	F	Linear	SRC_NONE	F	F	Linear	DST_LFO_FREQ
Mod LFO Start Delay	SRC_NONE	F	F	Linear	SRC_NONE	F	F	Linear	DST_LFO_DELAY
Vibrato LFO									
Vib LFO Frequency	SRC_NONE	F	F	Linear	SRC_NONE	F	F	Linear	DST_VIB_FREQ
Vib LFO Start Delay	SRC_NONE	F	F	Linear	SRC_NONE	F	F	Linear	DST_VIB_DELAY
Volume EG									
Vol EG Delay Time	SRC_NONE	F	F	Linear	SRC_NONE	F	F	Linear	DST_EG1_DELAYTIME
Vol EG Attack Time	SRC_NONE	F	F	Linear	SRC_NONE	F	F	Linear	DST_EG1_ATTACKTIME
Vol EG Hold Time	SRC_NONE	F	F	Linear	SRC_NONE	F	F	Linear	DST_EG1_HOLDTIME
Vol EG Decay Time	SRC_NONE	F	F	Linear	SRC_NONE	F	F	Linear	DST_EG1_DECAYTIME
Vol EG Sustain Level	SRC_NONE	F	F	Linear	SRC_NONE	F	F	Linear	DST_EG1_SUSTAINLEVEL
Vol EG Release Time	SRC_NONE	F	F	Linear	SRC_NONE	F	F	Linear	DST_EG1_RELEASETIME
Vol EG Shutdown Time	SRC_NONE	F	F	Linear	SRC_NONE	F	F	Linear	DST_EG1_SHUTDOWNTIME
Vol EG Velocity to Attack	SRC_KEYONVELOCITY	F	F	Linear	SRC_NONE	F	F	Linear	DST_EG1_ATTACKTIME
Vol EG Key to Decay	SRC_KEYNUMBER	F	F	Linear	SRC_NONE	F	F	Linear	DST_EG1_DECAYTIME
Vol EG Key to Hold	SRC_KEYNUMBER	F	F	Linear	SRC_NONE	F	F	Linear	DST_EG1_HOLDTIME
Modulator EG									
Mod EG Delay Time	SRC_NONE	F	F	Linear	SRC_NONE	F	F	Linear	DST_EG2_DELAYTIME
Mod EG Attack Time	SRC_NONE	F	F	Linear	SRC_NONE	F	F	Linear	DST_EG2_ATTACKTIME
Mod EG Hold Time	SRC_NONE	F	F	Linear	SRC_NONE	F	F	Linear	DST_EG2_HOLDTIME
Mod EG Decay Time	SRC_NONE	F	F	Linear	SRC_NONE	F	F	Linear	DST_EG2_DECAYTIME
Mod EG Sustain Level	SRC_NONE	F	F	Linear	SRC_NONE	F	F	Linear	DST_EG2_SUSTAINLEVEL
Mod EG Release Time	SRC_NONE	F	F	Linear	SRC_NONE	F	F	Linear	DST_EG2_RELEASETIME
Mod EG Velocity to Attack	SRC_KEYONVELOCITY	F	F	Linear	SRC_NONE	F	F	Linear	DST_EG2_ATTACKTIME

DOWNLOADABLE SOUNDS LEVEL 2.1

Articulator Name	UsSource (*)	B	I	Transform	UsControl (*)	B	I	Transform	UsDestination (*)
Mod EG Key to Decay	SRC_KEYNUMBER	F	F	Linear	SRC_NONE	F	F	Linear	DST_EG2_DECAYTIME
Mod EG Key to Hold	SRC_KEYNUMBER	F	F	Linear	SRC_NONE	F	F	Linear	DST_EG2_HOLDTIME
Key Number Generator									
MIDI Note to Key	SRC_MIDINOTE	F	F	Linear	SRC_NONE	F	F	Linear	DST_KEYNUMBER
RPN2 to Key	SRC_RPN2	T	F	Linear	SRC_NONE	F	F	Linear	DST_KEYNUMBER
Filter									
Initial F _c	SRC_NONE	F	F	Linear	SRC_NONE	F	F	Linear	DST_FILTER_CUTOFF
Initial Q	SRC_NONE	F	F	Linear	SRC_NONE	F	F	Linear	DST_FILTER_Q
Mod LFO to F _c	SRC_LFO	T	F	Linear	SRC_NONE	F	F	Linear	DST_FILTER_CUTOFF
Mod LFO CC1 to F _c	SRC_LFO	T	F	Linear	SRC_CC1	F	F	Linear	DST_FILTER_CUTOFF
Mod LFO Channel Pressure to F _c	SRC_LFO	T	F	Linear	SRC_CHANNEL PRESSURE	F	F	Linear	DST_FILTER_CUTOFF
Mod EG to F _c	SRC_EG2	F	F	Linear	SRC_NONE	F	F	Linear	DST_FILTER_CUTOFF
Velocity to F _c	SRC_KEYONVELOCITY	F	F	Linear	SRC_NONE	F	F	Linear	DST_FILTER_CUTOFF
Key Number to F _c	SRC_KEYNUMBER	F	F	Linear	SRC_NONE	F	F	Linear	DST_FILTER_CUTOFF
Gain									
Mod LFO to Gain (v2.1)	SRC_LFO	T	F	Linear	SRC_NONE	F	F	Linear	DST_GAIN
Mod LFO CC1 to Gain. (v2.1)	SRC_LFO	T	F	Linear	SRC_CC1	F	F	Linear	DST_GAIN
Mod LFO Channel Pressure to Gain	SRC_LFO	F	T	Linear	SRC_CHANNEL PRESSURE	F	F	Linear	DST_GAIN
Velocity to Gain	SRC_KEYONVELOCITY	F	T	Concave	SRC_NONE	F	F	Linear	DST_GAIN
MIDI CC7 to Gain	SRC_CC7	F	T	Concave	SRC_NONE	F	F	Linear	DST_GAIN
MIDI CC11 to Gain	SRC_CC11	F	T	Concave	SRC_NONE	F	F	Linear	DST_GAIN
Pitch									
Tuning	SRC_NONE	F	F	Linear	SRC_NONE	F	F	Linear	DST_PITCH
Pitch Wheel RPN0 to Pitch	SRC_PITCHWHEEL	T	F	Linear	SRC_RPN0	F	F	Linear	DST_PITCH
Key Number to Pitch	SRC_KEYNUMBER	F	F	Linear	SRC_NONE	F	F	Linear	DST_PITCH
RPN1 to Pitch	SRC_RPN1	T	F	Linear	SRC_NONE	F	F	Linear	DST_PITCH
Vib LFO to Pitch	SRC_VIBRATO	T	F	Linear	SRC_NONE	F	F	Linear	DST_PITCH
Vib LFO CC1 to Pitch	SRC_VIBRATO	T	F	Linear	SRC_CC1	F	F	Linear	DST_PITCH

DOWNLOADABLE SOUNDS LEVEL 2.1

Articulator Name	UsSource (*)	B	I	Transform	UsControl (*)	B	I	Transform	UsDestination (*)
Vib LFO Channel Pressure to Pitch	SRC_VIBRATO	T	F	Linear	SRC_CHANNEL PRESSURE	F	F	Linear	DST_PITCH
Mod LFO to Pitch	SRC_LFO	T	F	Linear	SRC_NONE	F	F	Linear	DST_PITCH
Mod LFO CC1 to Pitch	SRC_LFO	T	F	Linear	SRC_CC1	F	F	Linear	DST_PITCH
Mod LFO Channel Pressure to Pitch	SRC_LFO	T	F	Linear	SRC_CHANNEL PRESSURE	F	F	Linear	DST_PITCH
Mod EG to Pitch	SRC_EG2	T	F	Linear	SRC_NONE	F	F	Linear	DST_PITCH
Output									
Default Pan	SRC_NONE	F	F	Linear	SRC_NONE	F	F	Linear	DST_PAN
MIDI CC10 to Pan	SRC_CC10	T	F	Linear	SRC_NONE	F	F	Linear	DST_PAN
CC91 to Reverb Send	SRC_CC91	F	F	Linear	SRC_NONE	F	F	Linear	DST_REVERB
Default Reverb Send	SRC_NONE	F	F	Linear	SRC_NONE	F	F	Linear	DST_REVERB
CC93 to Chorus Send	SRC_CC93	F	F	Linear	SRC_NONE	F	F	Linear	DST_CHORUS
Default Chorus Send	SRC_NONE	F	F	Linear	SRC_NONE	F	F	Linear	DST_CHORUS

TABLE 2: DEFAULT CONNECTION BLOCKS

DLS Synthesizer Default, Minimum, Maximum and Unit Values for Connection Blocks

Unspecified connection blocks in a connection block list shall be set to the default value shown here by the DLS synthesis engine.

Articulator	Default Value	Min Value	Max Value	Units
Modulator LFO				
Mod LFO Frequency	5 Hz	0.1 Hz	20 Hz	Absolute Pitch
Mod LFO Start Delay	10 msecs	10 msecs	10 secs	Absolute Time
Vibrato LFO				
Vibrato LFO Frequency	5 Hz	0.1 Hz	20 Hz	Absolute Pitch
Vibrato LFO Start Delay	10 msecs	10 msecs	10 secs	Absolute Time
Vol EG				
Vol EG Delay Time	0 secs	0 secs	40 secs	Absolute Time
Vol EG Attack Time	0 secs	0 secs	40 secs	Absolute Time
Vol EG Hold Time	0 secs	0 secs	40 secs	Absolute Time
Vol EG Decay Time	0 secs	0 secs	40 secs	Absolute Time
Vol EG Sustain Level	100 %	0%	100%	Percent
Vol EG Release Time	0 secs	0 secs	40 secs	Absolute Time
Vol EG Shutdown Time	15 msecs	0 secs	40 secs	Absolute Time
Vol EG Velocity to Attack	0 Time Cents	0 Time Cents	6,000 Time Cents	Relative Time Cents
Vol EG Key to Decay	0 Time Cents	0 Time Cents	6,000 Time Cents	Relative Time Cents
Vol EG Key to Hold	0 Time Cents	0 Time Cents	6,000 Time Cents	Relative Time Cents
Modulator EG				
Mod EG Delay Time	0 secs	0 secs	40 secs	Absolute Time
Mod EG Attack Time	0 secs	0 secs	40 secs	Absolute Time
Mod EG Hold Time	0 secs	0 secs	40 secs	Absolute Time
Mod EG Decay Time	0 secs	0 secs	40 secs	Absolute Time
Mod EG Sustain Level	100%	0%	100%	Percent
Mod EG Release Time	0 secs	0 secs	40 secs	Absolute Time
Mod EG Velocity to Attack	0 Time Cents	0 Time Cents	6,000 Time Cents	Relative Time Cents
Mod EG Key to Decay	0 Time Cents	0 Time Cents	6,000 Time Cents	Relative Time Cents
Mod EG Key to Hold	0 Time Cents	0 Time Cents	6,000 Time Cents	Relative Time Cents
Key Number Generator				
MIDI Note to Key	12,800 cents	12,800 cents	12,800 cents	Relative Pitch
RPN2 to Key	6,400 cents	0 cents	6,400 cents	Relative Pitch

Articulator	Default Value	Min Value	Max Value	Units
Filter				
Initial F _c	0x7FFFFFFh	5535 cents	11921 cents	Absolute Pitch
Initial Q	0 dB	0 dB	22.5 dB	Relative Gain
Mod LFO to F _c	0 cents	-12800 cents	12800 cents	Relative Pitch
Mod LFO CC1 to F _c	0 cents	-12800 cents	12800 cents	Relative Pitch
Mod LFO Channel Press. to F _c	0 cents	-12800 cents	12800 cents	Relative Pitch
Mod EG to F _c	0 cents	-12800 cents	12800 cents	Relative Pitch
Velocity to F _c	0 cents	-12800 cents	12800 cents	Relative Pitch
Key Number to F _c	0 cents	-12800 cents	12800 cents	Relative Pitch
Gain				
Mod LFO to Gain	0 dB	0 dB	12 dB	Relative Gain
Mod LFO CC1 to Gain.	0 dB	0 dB	12 dB	Relative Gain
Mod LFO Chan. Press. to Gain.	0 dB	0 dB	12 dB	Relative Gain
Velocity to Gain	-96 dB	0 dB	-96 dB	Relative Gain
MIDI CC7 to Gain	-96 dB	-96 dB	-96 dB	Relative Gain
MIDI CC11 to Gain	-96 dB	-96 dB	-96 dB	Relative Gain
Pitch				
Tuning	0 cents	-1,200 cents	1,200 cents	Relative Pitch
Pitch Wheel RPN0 to Pitch	12,800 cents	12,800 cents	12,800 cents	Relative Pitch
Key Number to Pitch	12,800 cents	0 cents	12,800 cents	Relative Pitch
RPN1 to Pitch	100 cents	0 cents	100 cents	Relative Pitch
Vib LFO to Pitch	0 cents	-1,200 cents	1,200 cents	Relative Pitch
Vib LFO CC1 to Pitch	0 cents	-1,200 cents	1,200 cents	Relative Pitch
Vib LFO Chan. Press. to Pitch	0 cents	-1,200 cents	1,200 cents	Relative Pitch
Mod LFO to Pitch	0 cents	-1,200 cents	1,200 cents	Relative Pitch
Mod LFO CC1 to Pitch	0 cents	-1,200 cents	1,200 cents	Relative Pitch
Mod LFO Chan. Press. to Pitch	0 cents	-1,200 cents	1,200 cents	Relative Pitch
Mod EG to Pitch	0 cents	-1,200 cents	1,200 cents	Relative Pitch
Output				
Default Pan	0%	-50%	50%	0.1% units
MIDI CC10 to Pan	50.8%	-50.8%	50.8%	0.1% units
Default CC91 to Reverb Send	100%	0%	100%	0.1% units
Default Reverb Send	0%	0%	100%	0.1% units
Default CC93 to Chorus Send	100%	0%	100%	0.1% units
Default Chorus Send	0%	0%	100%	0.1% units

1.14 Data Format Definitions

The DLS device parameters are described in the following units:

1.14.1 Absolute Pitch

A signed, 32-bit unit for expressing Absolute Pitch in an exponential form to facilitate modulation in a musical fashion. The formula for converting frequency in Hertz to the DLS Absolute Pitch Unit is as follows:

$$\text{Absolute Pitch} = (1200 * \log_2(f / 440) + 6900) * 65536$$

Where f is the frequency of interest. Each absolute pitch unit represents 1/65536 cents.

1.14.2 Relative Pitch

A signed, 32-bit unit for expressing Absolute Pitch in an exponential form to facilitate modulation in a musical fashion. The formula for converting frequency in Hertz to the DLS Absolute Pitch Unit is as follows:

$$\text{Relative Pitch} = 1200 * \log_2(f / F) * 65536$$

Where F is the reference frequency and f is the frequency of interest. Each relative pitch unit represents 1/65536 cents.

1.14.3 Absolute Time

A signed, 32-bit unit for expressing absolute time in an exponential form to facilitate modulation in a musical fashion. The formula for converting time in seconds to the DLS Absolute Time Unit is as follows:

$$\text{Absolute Time} = 1200 * \log_2(\text{time}_{secs}) * 65536$$

Since it is impossible to represent zero in this format, the value 80000000h has been chosen to denote an absolute zero. When the value 80000000h is applied to a destination, that destination cannot be modified by other sources; it will always be zero.

1.14.4 Gain

A signed, 32-bit unit for expressing relative signal strengths in an exponential form to facilitate modulation in a musical fashion. Gain is calculated by the following formula:

$$\text{Gain Units} = 200 * \log_{10}(v / V) * 65536$$

Where V is the reference signal and v is the signal of interest. Positive values indicate gain, while negative values indicate attenuation. Each unit of gain represents 1/655360 dB. All references to gain or units of gain in this document refer to amplitude and not power.

1.14.5 Sample Frequency

A 32-bit unsigned integer, with the frequency specified in 1/1000th of Hertz.

1.14.6 Instrument

The instrument header determines the number of regions in an instrument, as well as its bank and program numbers. Each region contains at minimum a <rgnh-ck> region header chunk and a <wlnk-ck> wave link chunk. It may also optionally contain a <wsmp-ck> wave sample chunk, and a <lar2-ck> local articulation chunk.

cRegions	Specifies the count of regions for this instrument.
Locale	Specifies the MIDI locale (Bank and Program Change) for this instrument.

1.14.7 Region

The Region is used by the Control Logic to decide which sample to use. Each region provides velocity and note ranges to match against an incoming note. If these match, the sample is chosen for performance with the articulation and loop data selected by the region. The Region chunk also contains the Wave Link chunk and may contain local articulation.

RangeKey	Specifies the note range for this region.						
RangeVelocity	Specifies the velocity range for this region.						
fusOptions	Specifies flag options for the synthesis of this region. The only flag defined at this time is the <i>Self Non Exclusive</i> flag. See Note Exclusivity section for more detail.						
usKeyGroup	Specifies the key group for a drum instrument. Key group values allow multiple regions within a drum instrument to belong to the same "key group." If a synthesis engine is instructed to play a note with a key group setting and any other notes are currently playing with this same key group, the synthesis engine should turn off all notes with the same key group value as soon as possible. Valid values are: <table> <tr> <td>0</td> <td>No Key group</td> </tr> <tr> <td>1-15</td> <td>Key groups 1 to 15.</td> </tr> <tr> <td>All Others</td> <td>Reserved</td> </tr> </table>	0	No Key group	1-15	Key groups 1 to 15.	All Others	Reserved
0	No Key group						
1-15	Key groups 1 to 15.						
All Others	Reserved						
usLayer	Optional field for grouping regions into layers. This is intended to facilitate the user interface for editing programs and has no bearing on the synthesis of the sound. Programs may detect the existence of the <i>usLayer</i> field by examining the size of the <rghn-ck>. Programs that ignore <i>usLayer</i> must still preserve its value when writing data to a file.						

1.14.8 Wave Link

The Wave Link contains the link to the sample data. This is isolated from the region to allow for synthesis methods other than wavetable synthesis. The sample data is indexed through the Pool Table and the other fields provide the information to phase-lock multiple samples together to create stereo or even surround-sound images.

ulChannel	Specifies the channel placement of the sample. This is used to place mono sounds within a stereo pair or for multi-track placement. Each bit position within the <i>ulChannel</i> field specifies a channel placement with bit 0 specifying a mono sample or the left channel of a stereo sample. Bit 1 specifies the right channel of a stereo sample.
ulTableIndex	Specifies the 0 based index of the cue entry in the wave pool table.

1.14.9 Articulation

The Articulation data specifies a number of flexible connections for routing signals in the synthesizer. The DLS Device Architecture places a restriction on which connections are valid for different device levels. The chunk specifies the number of connections, followed by a list of connections.

cConnectionBlocks	Specifies the number (count) of ConnectionBlocks that are contained in the articulator chunk.
usSource	Specifies the source for the connection.
usControl	Specifies the control for the connection.
usDestination	Specifies the destination for the connection
usTransform	Specifies the transform used for the connection.
IScale	Specifies the scaling value used for the connection.

1.14.10 Wave Sample

The Wave Sample chunk contains the low level parameters for playing a sample. Normally it is contained within the Wave chunk itself, but may also be used at the Region level to override loop points or other parameters.

usUnityNote	Specifies the MIDI note which will replay the sample at original pitch. This value ranges from 0 to 127 (a value of 60 represents Middle C, as defined by the MIDI specification).
sFineTune	Specifies the tuning offset from the <i>usUnityNote</i> in 16 bit relative pitch.
lGain	Specifies the gain to be applied to this sample in 32 bit relative gain units. This is used primarily to balance multi-sample splits.
fulOptions	Specifies flag options for the digital audio sample. Flags are defined for disabling 16 bit to 8-bit truncation of samples and compression of samples by the driver.
cSampleLoops	Specifies the number (count) of loop records that are contained in the wave sample chunk. One-shot sounds will have the <i>cSampleLoops</i> field set to 0.
ulLoopType	Specifies the loop type.
ulLoopStart	Specifies the start point of the loop in samples as an absolute offset from the beginning of the data in the 'data' chunk of the sample.
ulLoopLength	Specifies the length of the loop in samples.

1.15 Tolerances

Discussions so far have been restricted primarily to the idealized synthesizer. While reducing this synthesizer to a practical working model, certain compromises will undoubtedly be made as a result of design tradeoffs. The purpose of this section is to lay out guidelines for allowable variances from the ideal synthesizer to accommodate tradeoffs made in the design process.

1.15.1 Digital Oscillator

The Digital Oscillator must have a minimum frequency resolution of 1 cent, +/-0.25 cents within the allowable pitch shift range of +/-4 octaves. The DLS Level 2 Synthesizer must have a minimum of 32 oscillators, and output sample rate must be 22KHz or better.

1.15.2 Digitally Controlled Filter

In realizing a practical filter from the ideal filter model, it is necessary to make certain compromises in the implementation. In order to accommodate variances in implementation, the actual filter response is permitted to vary from the ideal filter response described in this document as follows:

- A minimum of 16 discrete resonance values must be supported spanning the range from 0 *dB* to 22.5 *dB*. The discrete resonance values will be approximately linearly spaced (in *dB*) across that range. This corresponds to a step size of 1.5 *dB*. Up to 1.5 *dB* of error is tolerated for any resonance specified within the range 0 *dB* to 22.5 *dB*.
- When the cutoff frequency of a filter is swept with constant resonance, it is typical in many implementations for the actual height of the resonant peak to vary. A deviation of less than 3 *dB* per octave of sweep is required. Note that this is not achieved by simply varying the pole angle. The radius must be varied with the pole angle to achieve a deviation of less than 3 *dB*. The specified resonance in these cases is valid at 1 kHz and must be within 1.5 *dB* of the specified value.

- The maximum required resonance is 22.5 dB. Resonance may be specified greater than 22.5 dB but support is not guaranteed by all platforms. When the specified resonance is greater than that supported by a device, it will be rendered as the maximum resonance supported.
- The gain at DC must be within +/-0.75 dB of the ideal as specified by this document. The gain at all other frequencies must be within +/-1.5 dB of the ideal as specified by this document, with F_c of the ideal normalized to the actual F_c implemented by the filter.
- In most implementations, the actual cutoff frequency according to this specification will not exactly correspond to the specified frequency. A deviation of no more than one semitone is required to allow for tracking filters that are attempting to accentuate a particular harmonic.
- When sweeping the filter cutoff, a minimum of 2048 discrete cutoff frequencies per octave must be supported. The worst case spacing between any two adjacent discrete values must be no more than 0.01 semitones.
- The cutoff frequency according to this specification is not well defined as the resonance frequency approaches one octave below the Nyquist frequency, corresponding to a pole angle of $\pi/2$ radians. In fact, at a pole angle of $\pi/3$ radians and a radius of 0.9, the resonance frequency calculated by this method is almost exactly equal to $Nyquist/2$, even though the resonant peak is at $Nyquist/3$. Also, using these parameters, the calculated cutoff frequency intersects the filter response curve at 0 dB. As the pole angle is increased, filters specified in this manner change from low-pass to a simple resonator with no attenuation, and finally to a high-pass characteristic (actually only providing high frequency gain). In view of these facts, and that second order filters of this type will not have dramatic effect on the sound in this case, cutoff frequencies when calculated according to this specification are only required up to $1/6^{\text{th}}$ of the sample rate F_s . Higher cutoff frequencies may be specified, but support is not guaranteed by all platforms. When the specified cutoff frequency is greater than that supported by a device, it will be rendered as the maximum cutoff frequency supported. The one exception to this rule is that when the specified cutoff frequency is greater than the Nyquist frequency, the filter will have a flat passband characteristic, regardless of the specified resonance. In other words, the filter will be *off* in this case. It is recommended to content developers that they specify the maximum value, or 0x7FFFFFFF, for filter cutoff when no low pass filter is desired, but devices will respond as defined in this text.
- Cutoff frequencies must be supported within the range $F_s/240$ to $F_s/6$, where F_s is the output sample rate of the device.
- The maximum THD+N must be no more than 0.005% of full scale for sinusoidal inputs at all values of F_c and resonance.

1.15.3 Digitally Controlled Amplifier

The Digitally Controlled Amplifier must have a minimum amplitude resolution of 1 dB, +/-0.25 dB from unity gain down to -85 dB in response to external controls and generators. These controls should feed an internal ramp generator that interpolates between control events. The internal resolution of the ramp generator must be no less than 0.0025 dB to prevent zipper noise from generators or external controls.

1.15.4 LFO Generator

The LFO generators must be accurate to within 1% of the specified frequency (averaged over 100 cycles) with jitter of no more than 10 milliseconds. Delay times must be accurate to within +/-10 milliseconds.

1.15.5 Envelope Generator

The Envelope Generators must be accurate to within 0.5 dB. Timing must be accurate to within +/-10 milliseconds.

1.16 DLS System Exclusive Messages

The following messages are used to control the behavior of the DLS device.

Turn DLS On:

F0 7E < device ID > 0A 01 F7

F0 7E	Universal Non-Real Time SysEx header
< device ID >	ID of target device (suggest using 7F: Broadcast)
0A	sub-ID #1 = DLS message
01	sub-ID #2 = DLS On
F7	EOX

Turn DLS Off:

F0 7E < device ID > 0A 02 F7

F0 7E	Universal Non-Real Time SysEx header
< device ID >	ID of target device (suggest using 7F: Broadcast)
0A	sub-ID #1 = DLS message
02	sub-ID #2 = DLS Off
F7	EOX

Turn DLS Static Voice Allocation Off:

F0 7E < device ID > 0A 03 F7

F0 7E	Universal Non-Real Time SysEx header
< device ID >	ID of target device (suggest using 7F: Broadcast)
0A	sub-ID #1 = DLS message
03	sub-ID #2 = DLS StaticVoice Allocation Off
F7	EOX

Turn DLS Static Voice Allocation On:

F0 7E < device ID > 0A 04 F7

F0 7E	Universal Non-Real Time SysEx header
< device ID >	ID of target device (suggest using 7F: Broadcast)
0A	sub-ID #1 = DLS message
04	sub-ID #2 = DLS Static Voice Allocation On
F7	EOX

2. DLS File RIFF Structure

2.1 RIFF Format

DLS instruments are stored in a RIFF form of type 'DLS'. The subchunks of this form are the 'cdl', 'vers', 'dlid', 'colh', 'ptbl', ' and 'LIST' chunks. There are three top-level LIST chunks: the <lins-list> instrument list chunk contains <ins-list> instrument subchunks; and the <wvpl-list> wave pool chunk contains <wave-list> subchunks (similar to wave files), and the optional <INFO-list> info list chunk contains information about the collection.

The <colh-ck> chunk defines the number of instruments in the collection. The <ptbl-ck> chunk contains a list of reference entries to digital audio data. The <ins-list> subchunks within the <lins-list> chunk are the actual instruments stored in this collection.

The optional chunk <cdl-ck> provides a means for restricting use to compatible devices when used at the top level. The optional <vers-ck> provides a means for identifying the version of the file content. The <dlid-ck> provides a means of managing resources, particularly in an Internet setting.

2.2 RIFF Structure

The following is a RIFF grammar¹ that describes the downloadable instrument collection:

```

<DLS-form>  →      RIFF( 'DLS '                                // Collection
                    [<cdl-ck>]
                    [<vers-ck>]
                    [<dlid-ck>]
                    <colh-ck>
                    <lins-list>
                    <ptbl-ck>
                    <wvpl-list>
                    [<INFO-list>]
                    )

<wvpl-list> →      LIST( 'wvpl' <wave-list>... )           // Wave Pool

<wave-list> →      LIST( 'wave'                               // Wave File
                    [<dlid-ck>]
                    <fmt-ck>
                    <data-ck>
                    [<wsmp-ck>]
                    [<INFO-list>]
                    )

<lins-list> →      LIST( 'lins' <ins-list>... )           // List of Instruments

<ins-list>  →      LIST( 'ins '                               // Instrument
                    [<dlid-ck>]
                    <insh-ck>
                    <lrgn-list>
                    [<lart-list>]
                    [<lar2-list>]
                    [<INFO-list>]
                    )

<lrgn-list> →      LIST( 'lrgn' <rgn-list> | <rgn2-list>... ) // Region list

<rgn-list>  →      LIST( 'rgn '                               // L1 Region

```

0_____

¹ See Microsoft Windows Multimedia Programmer's Reference

```

        [<cdl-ck>]
        <rgnh-ck>
        <wsmp-ck>
        [<wlnk-ck>]
        [<lrt-list>]
        [<lar2-list>]
        [<INFO-list>]
    )

<rgn2-list> → LIST('rgn2' // L2 Region
        [<cdl-ck>]
        <rgnh-ck>
        <wsmp-ck>
        [<wlnk-ck>]
        [<lar2-list>]
        [<INFO-list>]
    )

<lrt-list> → LIST( 'lrt' [<cdl-ck>], <art1-ck>... )// List of Articulators
<lar2-list> → LIST( 'lar2' [<cdl-ck>], <art2-ck>... )// List of Articulators
<INFO-list> → LIST( 'INFO' <info_text-ck>... )

```

TABLE 3: RIFF DEFINITIONS

RIFF Chunk	Definition
<colh-ck>	A DLS collection header as defined later in this document.
<dliid-ck>	A globally unique identifier chunk as defined later in this document.
<cdl-ck>	A conditional chunk as defined later in this document.
<insh-ck>	An instrument header chunk as defined later in this document.
<rgnh-ck>	A region header chunk as defined later in this document.
<art1-ck>	A Level 1 articulator data chunk as defined later in this document.
<art2-ck>	A Level 2 articulator data chunk as defined later in this document.
<wlnk-ck>	A wave link chunk as defined later in this document.
<wsmp-ck>	A wave sample chunk as defined later in this document.
<ptbl-ck>	A pool table data chunk as defined later in this document.
<vers-ck>	An optional version chunk as defined later in this document.
<wave-list>	A DLS wave file chunk.
<info_text-ck>	A text chunk within an <INFO-list> chunk as defined later in this document.

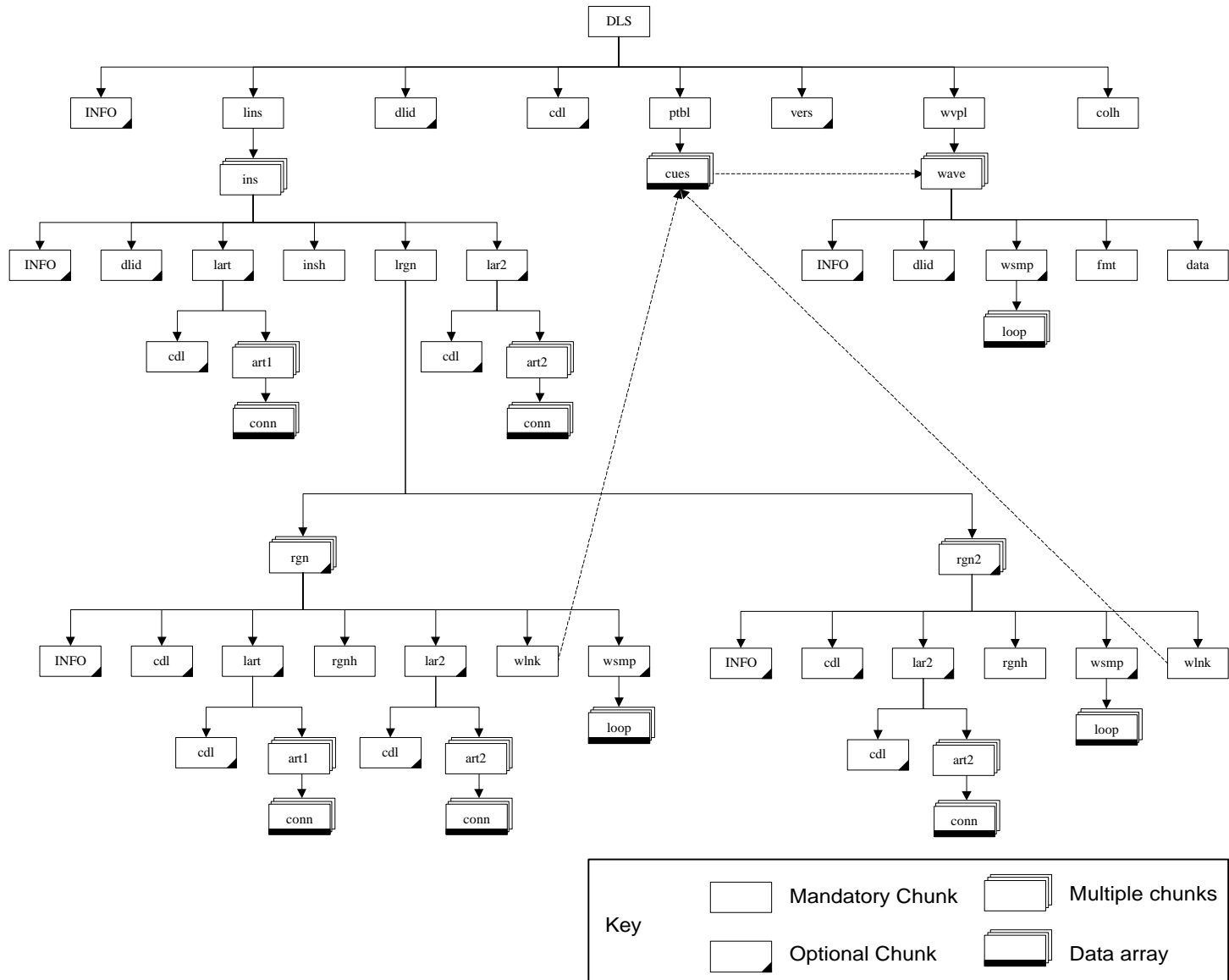

Figure 12: DLS File Format

2.3 LIST Chunk

A LIST chunk contains a list, or ordered sequence, of subchunks. A LIST chunk is defined as follows:

```
LIST( <list-type> [<chunk>]... )
```

The <list-type> is a four-character code that identifies the contents of the list.

If an application recognizes the list type, it should know how to interpret the sequence of subchunks. However, since a LIST chunk may contain only subchunks (after the list type), an application that does not know about a specific list type can still walk through the sequence of subchunks.

Like chunk IDs, list types must be registered, and an all-lowercase list type has meaning relative to the form that contains it.

2.4 <colh-ck>, Collection Header Chunk

The <colh-ck> collection header defines an instrument collection. The <colh-ck> is defined as follows:

```
<colh-ck>    →    colh( <cInstruments:ULONG> )
```

Field	Description
cInstruments	Specifies the count of instruments in this collection, and indicates the number of <ins-ck> instrument chunks in the 'lins' list. This enables the file parser to pre-allocate memory for storage of instruments. If the <i>cInstruments</i> field does not match the 'lins' count, the DLS file is in error. It is recommended that sound development tools allow the user to ignore this error and correct the <i>cInstruments</i> field to reflect the actual number of instruments in the collection.

A <colh-ck> chunk is typically (but not necessarily) the second chunk within the enclosing <DLS-form> collection chunk.

2.5 <dldid-ck>, DLSID Chunk

The <dldid-ck> defines an optional globally unique identifier (DLSID) for a complete <DLS-form> or for an element within it. A DLSID is identical to an OSF/DCE 'UUID' (also known as a Microsoft® 'GUID', 'CLSID', 'IID' or 'FMTID'). The <dldid-ck> is defined as follows:

```
<dldid-ck>    →    dldid( <DLSID> )

<DLSID>       →    struct
                    {
                    ULONG  ulData1;
                    USHORT usData2;
                    USHORT usData3;
                    BYTE   abData4[8];
                    }
```

The <dldid-ck> chunk:

Field	Description
DLSID	Specifies a 128-bit (16 byte) integer used as a globally unique identifier for a content element. The DCE standard specifies that the string representation for a UUID contains five fixed-length, hyphen-delimited groups of hexadecimal digits, grouped 8-4-4-4-12, as shown: 60DF3430-0266-11cf-BAA6-00AA003E0EED

The <DLSID> structure:

Field	Description
ulData1	Contains the binary value of the first group of the string value (8 hexadecimal digits).
usData2	Contains the binary value of the second group of the string value (4 hexadecimal digits).
usData3	Contains the binary value of the third group of the string value (4 hexadecimal digits).
abData4[8]	Contains the fourth and fifth groups of the string value. Array elements 0 and 1 of hold the fourth group (4 digits), while elements 2 through 7 hold the final group (12 digits).

The C declaration for the example DLSID would be:

```
const DLSID example =
    { 0x60df3430, 0x0266, 0x11cf, { 0xba, 0xa6, 0x00, 0xaa, 0x00, 0x3e, 0x0e, 0xed } };
```

The actual hexadecimal byte sequence (in ascending order) would be:

```
30 34 DF 60 66 22 CF 11 BA A6 00 AA 00 3E 0E ED
```

Byte order in the first three fields appears reversed because Intel® (little-endian) binary representation is used.

The DLSID value must be generated *by computer and never manually*, in order to obtain a unique value (software for this purpose is commonly available). The DLSID must be generated using the UUID algorithm specified by OSF DCE², which uses a combination of the following information to generate the value:

- The current date and time
- A *clock sequence* and related persistent state to deal with retrograde motion of clocks
- A forcibly incremented counter to deal with high-frequency allocations
- A globally unique IEEE machine identifier, obtained from a network card. (If no network card is present, a machine identifier may be synthesized from highly variable machine states and stored persistently).

A DLSID uniquely designates a particular DLS resource (collection, instrument, wave file, or capability). If the resource is modified in any way *whatsoever*, a new DLSID must be generated and attached to that resource. Therefore, changing an instrument or wave file also requires changing the DLSID for the enclosing collection.

DLSIDs provide four principal benefits:

- They allow DLS Devices to detect multiply-referenced resources and share a single copy of the data.
- They allow an application to determine whether a DLS resource located on a remote network site is already present on the local system, before downloading the resource.
- They facilitate searching for a particular resource and building special-purpose collections.
- They support error recovery. A DLS manager applet can identify and recover "orphan" resources left in a locked state by a faulty application.
- They provide a way of uniquely identifying various capabilities of the device, which combined with the Conditional Chunk, facilitates forward- and backward-compatibility of instrument collections.

DLSID chunks are not required in DLS files.

0_____

² Chapter 10, "DEC/HP Network Computing Architecture Remote Procedure Call RunTime Extensions Specification Version OSF TX1.0.11", Steven Miller, July 23 1992.

2.6 <cdl-ck>, Conditional Chunk

The <cdl-ck> conditional chunk is an optional chunk that can only be found in a list and defines the set of conditions under which the associated chunks in the list are to be used. The <cdl-ck> is defined as follows:

```

<cdl-ck>    →    cdl (  <Operation>
                    [[<Operation>]...]
                )

<Operation> →    USHORT      Opcode;

                -or-

                struct
                {
                    USHORT      Opcode;
                    DLSID        Query;
                }

                -or-

                struct
                {
                    USHORT      Opcode;
                    ULONG        Constant;
                }
    
```

The <cdl-ck> consists of a list of opcodes, which may optionally be followed by: a DLSID (GUID) which represents a query to the DLS device; or by a 32-bit unsigned integer constant. The <cdl-ck> creates an extendable, reverse-polish-notation (RPN) grammar for querying a device. On the basis of the query results, the file parser will then either use or discard the contents of the list within which the <cdl-ck> is contained. It is recommended, but not required, that the <cdl-ck> appear as the first subchunk in the list to allow the parser to decide whether to parse or ignore the list contents prior to actually parsing any subchunks in the list.

In the event that a conditional chunk exists at the top level of the DLS form, and the DLS device fails the conditional tests specified within that chunk, the entire DLS file is to be ignored. In this event, an error code should be returned to the application code through the driver interface indicating that the device does not support the required features set for this file. It is recommended that development tools such as sound editors allow the user to ignore such an error and proceed with the download as a means of porting sounds from one device type to another.

The DLS Level 2 device must support a minimum of eight (8) 32-bit words of accumulator stack for storing temporary values. An opcode may designate an unsigned integer constant, a device query, or a math operation. In the case of a DLS_CDL_CONST opcode, the supplied value is pushed onto the accumulator stack. In the case of the DLS_CDL_QUERY opcode, the device is queried, and the return value is pushed onto the accumulator stack. If the DLSID query is not supported, a FALSE value is pushed onto the stack.

In the case of the DLS_CDL_QUERY_SUPPORTED opcode, the device is queried and if it supports the query, a TRUE value is pushed on the stack, otherwise a FALSE value is pushed on the stack. Note that the DLS_CDL_QUERY_SUPPORTED opcode requires that interface to the device make the distinction between a query that is unsupported, and a query that returns FALSE.

In the case of a unary operator such as DLS_CDL_NOT, the value on the top of the stack is popped off, logically inverted, and then pushed back on the stack. In the case of a binary operator, such as DLS_CDL_GT, the two values on the top of the stack are popped off, compared, and the logical result is pushed onto the stack.

When the file parser reaches the end of the <cdl-ck> conditional chunk, the value on the top of the stack is examined, and if it evaluates as logically true, the list that contains the conditional chunk is parsed. If the value is false, the entire list is discarded.

DOWNLOADABLE SOUNDS LEVEL 2.1

Logical results are represented as follows: FALSE equates to all zeroes, TRUE equates to all ones. However, any non-zero value used as a logical result will be evaluated as TRUE. Therefore the DLS_CDL_NOT opcode must change any non-zero value to zero.

The follow table describes the opcodes that are valid in a <cdl-ck>. X is assumed to be the value at the top of the stack, Y is assumed to be the previous value on the stack, and Z is a 32-bit constant that only follows the DLS_CDL_CONST opcode. The results of the operation are pushed onto the stack.

Opcode	Value	Equivalent C Code
DLS_CDL_AND	0x0001	$X = X \& Y$
DLS_CDL_OR	0x0002	$X = X Y$
DLS_CDL_XOR	0x0003	$X = X \wedge Y$
DLS_CDL_ADD	0x0004	$X = X + Y$
DLS_CDL_SUBTRACT	0x0005	$X = X - Y$
DLS_CDL_MULTIPLY	0x0006	$X = X * Y$
DLS_CDL_DIVIDE	0x0007	$X = X / Y$
DLS_CDL_LOGICAL_AND	0x0008	$X = X \&\& Y$
DLS_CDL_LOGICAL_OR	0x0009	$X = X Y$
DLS_CDL_LT	0x000A	$X = (X < Y)$
DLS_CDL_LE	0x000B	$X = (X <= Y)$
DLS_CDL_GT	0x000C	$X = (X > Y)$
DLS_CDL_GE	0x000D	$X = (X >= Y)$
DLS_CDL_EQ	0x000E	$X = (X == Y)$
DLS_CDL_NOT	0x000F	$X = !X$
DLS_CDL_CONST	0x0010	$X = Z$
DLS_CDL_QUERY	0x0011	$X = \text{Query}(\text{DLSID})$ (see text)
DLS_CDL_QUERY_SUPPORTED	0x0012	$X = \text{QuerySupported}(\text{DLSID})$ (see text)

The DLS_CDL_QUERY and DLS_CDL_QUERY_SUPPORTED opcodes are followed by a DLSID that uniquely describes the feature to be queried. Additional DLSID's may be defined by device manufacturers using the specified algorithm to describe features proprietary to that device. NOTE: *It is important that all proprietary DLSID's be generated according to the proscribed algorithm to guarantee that unique ID's are generated.*

All DLS Level 2 devices must support the following queries:

DLSID Query	Description
DLSID_SupportsDLS1	Returns TRUE if device supports DLS Level 1
DLSID_SupportsDLS2	Returns TRUE if device supports DLS Level 2
DLSID_ManufacturersID	Returns MIDI Manufacturers ID in low 24 bits.
DLSID_ProductID	Returns Product ID (manufacturer specific)
DLSID_GMInHardware	Returns TRUE if device supports General MIDI in hardware
DLSID_SampleMemorySize	Returns the amount of memory available in the device in samples
DLSID_SamplePlaybackRate	Returns the true sample playback rate of the device in Hertz

The numeric values for the above DLSID's can be found in the DLS Level 2 Header File in this document.

2.6.1 DLS Level 1 and Level 2 Compatibility

Through the use of the Conditional Chunk, it is possible to create an instrument collection that is fully compatible with a DLS Level 1 Device, while also taking advantage of features of DLS Level 2 Device.

Since the DLS Level 1 Device does not support the <cdl-ck> Conditional Chunk, but is required to ignore any chunk it does not support, it is safe to include the <cdl-ck> chunk in an <art-ck> chunk, <rgn-ck> chunk, or <lrn-ck> list. The following conditional chunk will act as a sentinel to prevent a DLS Level 2 device from accessing chunks intended for a DLS Level 1 device, while simultaneously allowing a Level 1 device to freely access them:

```
cdl(  DLS_CDL_QUERY(DLSID_SupportsDLS2)
      DLS_CDL_NOT
)
```

The DLS Level 2 device will recognize the query and respond TRUE, causing the file parser to ignore the DLS Level 1 blocks. Data intended for the DLS Level 2 can then be placed inside 'lar2' or 'rgn2' chunks and thus isolated from the DLS Level 1 device, which will ignore those chunks. Adding a conditional chunk that requires support for DLS Level 2 further isolates the blocks from possible future incompatibilities:

```
cdl(  DLS_CDL_QUERY(DLSID_SupportsDLS2)
)
```

Finally, adding the following conditional chunk at the beginning of the file will help establish the overall compatibility of the file:

```
cdl(  DLS_CDL_QUERY(DLSID_SupportsDLS1)
      DLS_CDL_QUERY(DLSID_SupportsDLS2)
      DLS_CDL_LOGICAL_OR
)
```

The above chunk requires that the device support either DLS Level 1 or Level 2 in order to continue processing the file. As noted previously, development tools should have a mode that allows the user to override the conditional chunk as a means of moving sounds between otherwise incompatible devices.

There are several methods that can be used to create files that take advantage of DLS Level 2 features when available while still maintaining compatibility with DLS Level 1 devices. One method involves creating a completely separate set of <rgn2-ck> chunks with data specific to the DLS Level 2 device, and putting a 'NOT DLS LEVEL 2' conditional chunk on the <rgn-ck> chunks to prevent the DLS Level 2 device from trying to access DLS Level 1 chunks. This also allows for different samples to be played for DLS Level 1 and Level 2 devices. This allows the sound designer the opportunity to take advantage of the resonant filters in the DLS Level 2 device, and use a sampled filter sweep in the DLS Level 1 device with slightly less satisfactory results, but still compatible.

Another method is to simply augment the DLS Level 1 data with DLS Level 2 articulation data. This can be accomplished by putting the basic synthesis parameters into the <art1-ck> chunk, and putting only the DLS Level 2 extensions in the <art2-ck> chunk.

2.7 <insh-ck>, Instrument Header Chunk

The <insh-ck> defines an instrument within a collection. The <insh-ck> is defined as follows:

```
<insh-ck>    →    insh(
                    <cRegions:ULONG>
                    <Locale:MIDILOCALE>
                )
```

The <insh-ck> chunk:

Field	Description
cRegions	Specifies the count of regions for this instrument.
Locale	Specifies the MIDI locale for this instrument.

Additional Structure Definitions:

```
typedef struct _MIDILOCALE
{
    ULONG ulBank;
    ULONG ulInstrument;
} MIDILOCALE, *MIDILOCALE;
```

Field	Description
ulBank	Specifies the MIDI bank location. Bits 0-6 are defined as MIDI CC32 and bits 8-14 are defined as MIDI CC0. Bits 7 and 15-30 are reserved and should be written to zero. If the F_INSTRUMENT_DRUMS flag (Bit 31) is equal to 1 then the instrument is a drum instrument; if equal to 0 then the instrument is a melodic instrument.
ulInstrument	Specifies the MIDI Program Change (PC) value. Bits 0-6 are defined as PC value and bits 7-31 are reserved and should be written to zero.

An <insh-ck> instrument header is typically (but not necessarily) the *second* chunk within the enclosing <ins-list> instrument chunk. Other chunks at the same nesting level include a <lrgn-list> list of regions chunk, and an optional <lrt-list> list of articulators chunk (for melodic instruments only).

2.8 <rgnh-ck>, Region Header Chunk

The <rgnh-ck> defines a region within an instrument. The <rgnh-ck> is defined as follows:

```
<rgnh-ck>    →    rgnh(
                    <RangeKey:RGNRANGE>
                    <RangeVelocity:RGNRANGE>
                    <fusOptions:USHORT>
                    <usKeyGroup:USHORT>
                    [ <usLayer:USHORT> ]
                )
```

The <rgnh-ck> chunk:

Field	Description
RangeKey	Specifies the key range for this region.
RangeVelocity	Specifies the velocity range for this region.
fusOptions	Specifies flag options for the synthesis of this region. Current options are: F_RGN_OPTION_SELFNONEXCLUSIVE This option specifies that if a second Note-On of the same note is received by the synthesis engine, then the second note will be played as well as the first. This option is off by default and the synthesis engine will force a Note-Off of the prior note if a second note is received of the same value.
usKeyGroup	Specifies the key group for a drum instrument. Key group values allow multiple regions within a drum instrument to belong to the same "key group." If a synthesis engine is instructed to play a note with a key group setting and any other notes are currently playing with this same key group, then the synthesis engine should turn off all notes with the same key group value as soon as possible. Valid values are: 0 = no key group Valid key groups are 1 to 15. All Others Reserved
usLayer	[Optional] Indicates the layer of this region for editing purposes. This field facilitates the organization of overlapping regions into layers for display to the user of a DLS sound editor. For example, if a piano sound and a string section are overlapped to create a piano/string pad, all the regions of the piano might be labeled as layer 1, and all the regions of the string section might be labeled as layer 2. The program must read the <rgnh-ck> chunk size to determine whether the <i>usLayer</i> field exists in the chunk. Programs that do not support the <i>usLayer</i> field should preserve the value and write it back to the file. 0 = no layer information non-zero = valid layer

Additional Structure Definitions:

```
typedef struct _RGNRANGE
{
    USHORT usLow;           /* Low Value of Range */
    USHORT usHigh;        /* High Value of Range*/
} RGNRANGE, *RGNRANGE;
```

A <rgnh-ck> region header is typically (but not necessarily) the *first* chunk within the enclosing <rgn-list> region chunk. Other chunks at the same nesting level include a <wsmp-ck> wave sample chunk, a <wlnk-ck> wave link chunk, and an optional <art-list> list of articulators chunk (for drum instruments only).

2.9 <art1-ck>, Level 1 Articulator Chunk

The <art1-ck> articulator chunk specifies parameters which modify the playback of a sample used in DLS Level 1 downloadable instruments. The <art1-ck> chunk may exist at either the instrument level, in which case it contains global articulation data, or at the region level, in which case it contains local articulation data. However, the DLS Level 1 architecture restricts melodic instruments to only global articulation data and restricts drum instruments to only local articulation data.

The <art1-ck> chunk is defined as follows:

```

<art1-ck>    →    art1(
                    <cbSize:ULONG>
                    <cConnectionBlocks:ULONG>
                    <ConnectionBlock(s)>...
                )

<ConnectionBlock> → struct
                    {
                        USHORT usSource;
                        USHORT usControl;
                        USHORT usDestination;
                        USHORT usTransform;
                        LONG    lScale;
                    }
    
```

The <art1-ck> chunk:

Field	Description
cbSize	Specifies the size of the structure in bytes. <i>This size does not include the connection blocks.</i> This field is needed to distinguish the amount of data in the structure versus the list of connections and allow for additions to this structure in the future. This cannot be determined from the chunk size.
cConnectionBlocks	Specifies the number (count) of <ConnectionBlock> records that are contained in the <art2-ck> articulator chunk. The <ConnectionBlock> records are stored immediately following the cConnectionBlocks data field.

The <ConnectionBlock> structure:

Field	Description
usSource	Specifies the source for the connection.
usControl	Specifies the control for the connection.
usDestination	Specifies the destination for the connection
usTransform	Specifies the input and output transforms used for the connection.
lScale	Specifies the scaling value used for the connection.

The list of connection blocks defines both the architecture and settings for an instrument or instrument region. Although this could be defined as a simple structure of values, the connection graph model allows for future chunk types which will have a much greater possible number of connections, making the use of a structure unwieldy.

By using the connection graph, a single model can be used for future architectures.

Table 4 lists the defined sources, controls, destinations, and transforms of a DLS Level 1 synthesizer:

Table 4: Level 1 Sources, Controls, Destinations, and Transforms

Modulator Sources

0x0000	CONN_SRC_NONE	No Source
0x0001	CONN_SRC_LFO	Low Frequency Oscillator
0x0002	CONN_SRC_KEYONVELOCITY	Note-On Velocity
0x0003	CONN_SRC_KEYNUMBER	Note Number
0x0004	CONN_SRC_EG1	Envelope Generator 1
0x0005	CONN_SRC_EG2	Envelope Generator 2
0x0006	CONN_SRC_PITCHWHEEL	Pitch Wheel

MIDI Controller Sources

0x0081	CONN_SRC_CC1	Modulation
0x0087	CONN_SRC_CC7	Channel Volume
0x008a	CONN_SRC_CC10	Pan
0x008b	CONN_SRC_CC11	Expression

Registered Parameter Numbers

0x0100 [DLS1]	CONN_SRC_RPN0	RPN0 - Pitch Bend Range
0x0101	CONN_SRC_RPN1	RPN1 - Fine Tune
0x0102	CONN_SRC_RPN2	RPN2 - Coarse Tune

Generic Destinations

0x0000	CONN_DST_NONE	No Destination
0x0001	CONN_DST_GAIN	Gain
0x0002	CONN_DST_RESERVED	Reserved – DO NOT USE
0x0003	CONN_DST_PITCH	Pitch
0x0004	CONN_DST_PAN	Pan

Modulator LFO Destinations

0x0104	CONN_DST_LFO_FREQUENCY	LFO Frequency
0x0105	CONN_DST_LFO_STARTDELAY	LFO Start Delay Time

EG Destinations

0x0206	CONN_DST_EG1_ATTACKTIME	EG1 Attack Time
0x0207	CONN_DST_EG1_DECAYTIME	EG1 Decay Time
0x0208	CONN_DST_EG1_RESERVED	Reserved – DO NOT USE
0x0209	CONN_DST_EG1_RELEASETIME	EG1 Release Time
0x020A	CONN_DST_EG1_SUSTAINLEVEL	EG1 Sustain Level
0x030A	CONN_DST_EG2_ATTACKTIME	EG2 Attack Time
0x030B	CONN_DST_EG2_DECAYTIME	EG2 Decay Time
0x030C	CONN_DST_EG2_RESERVED	Reserved – DO NOT USE
0x030D	CONN_DST_EG2_RELEASETIME	EG2 Release Time
0x030E	CONN_DST_EG2_SUSTAINLEVEL	EG2 Sustain Level

Transforms

0x0000	CONN_TRN_NONE	No Transform
0x0001	CONN_TRN_CONCAVE	Concave Transform

2.10 <art2-ck>, Level 2 Articulator Chunk

The <art2-ck> articulator chunk specifies parameters which modify the playback of a sample used in DLS Level 2 downloadable instruments. The <art2-ck> chunk may exist at either the instrument level, in which case it contains global articulation data, or at the region level, in which case it contains local articulation data. The <art2-ck> chunk is defined as follows:

```

<art2-ck>   →   art2(
                <cbSize:ULONG>
                <cConnectionBlocks:ULONG>
                <ConnectionBlock(s)>...
            )

<ConnectionBlock> → struct
{
    USHORT usSource;
    USHORT usControl;
    USHORT usDestination;
    USHORT usTransform;
    LONG   lScale;
}
    
```

The <art2-ck> chunk:

Field	Description
cbSize	Specifies the size of the structure in bytes. <i>This size does not include the connection blocks.</i> This field is needed to distinguish the amount of data in the structure versus the list of connections and to allow for additions to this structure in the future. This cannot be determined from the chunk size.
cConnectionBlocks	Specifies the number (count) of <ConnectionBlock> records that are contained in the <art2-ck> articulator chunk. The <ConnectionBlock> records are stored immediately following the cConnectionBlocks data field.

The <ConnectionBlock> structure:

Field	Description
usSource	Specifies the source for the connection.
usControl	Specifies the control for the connection.
usDestination	Specifies the destination for the connection
usTransform	Specifies the input and output transforms used for the connection.
lScale	Specifies the scaling value used for the connection.

The *usTransform* field contains information that indicates the type of transforms that apply to the *usSource*, *usControl* source inputs and the also the output transform. The fields are as follows:

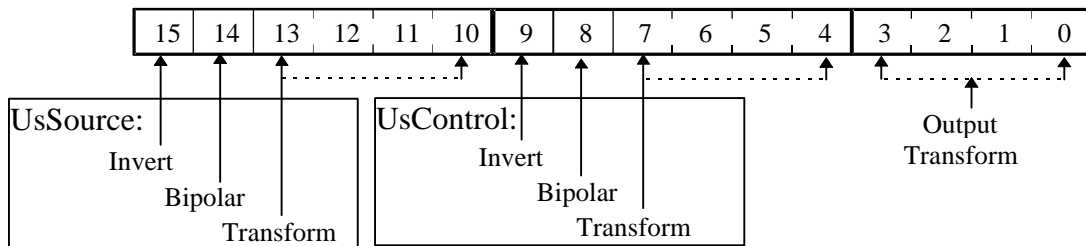

Figure 13: usTransform Field

Bits 0-3 specify one of 16 possible output transforms. Bits 4-7 specify one of 16 possible transforms to apply to the *usControl* input. Bits 8 and 9 specify whether the *usControl* input should be inverted and/or bipolar. Bits 10-13 specify one of 16 possible transforms to apply to the *usSource* input. Bit 14 and 15 specify whether the *usSource* input should be inverted and/or bipolar.

The list of connection blocks defines both the architecture and settings for an instrument or instrument region. Although this could be defined as a simple structure of values, the connection graph model allows for future chunk types which will have a much greater possible number of connections, making the use of a structure unwieldy.

By using the connection graph, a single model can be used for future architectures.

Table 5 lists the defined sources, controls, destinations, and transforms of a DLS synthesizer.

Table 5: Level 2 Sources, Controls, Destinations, and Transforms

Modulator Sources

0x0000	CONN_SRC_NONE	No Source
0x0001	CONN_SRC_LFO	Low Frequency Oscillator
0x0002	CONN_SRC_KEYONVELOCITY	Note-On Velocity
0x0003	CONN_SRC_KEYNUMBER	Note Number
0x0004	CONN_SRC_EG1	Envelope Generator 1
0x0005	CONN_SRC_EG2	Envelope Generator 2
0x0006	CONN_SRC_PITCHWHEEL	Pitch Wheel
0x0007	CONN_SRC_POLYPRESSURE	Polyphonic Pressure
0x0008	CONN_SRC_CHANNELPRESSURE	Channel Pressure
0x0009	CONN_SRC_VIBRATO	Vibrato LFO

MIDI Controller Sources

0x0081	CONN_SRC_CC1	Modulation
0x0087	CONN_SRC_CC7	Channel Volume
0x008a	CONN_SRC_CC10	Pan
0x008b	CONN_SRC_CC11	Expression
0x00db	CONN_SRC_CC91	Chorus Send
0x00dd	CONN_SRC_CC93	Reverb Send

Registered Parameter Numbers

0x0100 [DLS2]	CONN_SRC_RPN0	RPN0 - Pitch Bend Range
0x0101	CONN_SRC_RPN1	RPN1 - Fine Tune
0x0102	CONN_SRC_RPN2	RPN2 - Coarse Tune

Generic Destinations

0x0000	CONN_DST_NONE	No Destination
0x0001	CONN_DST_GAIN	Gain
0x0002	CONN_DST_RESERVED	Reserved
0x0003	CONN_DST_PITCH	Pitch
0x0004	CONN_DST_PAN	Pan
0x0005	CONN_DST_KEYNUMBER	Key Number Generator

Channel Output Destinations

0x0010	CONN_DST_LEFT	*Left Channel Send
0x0011	CONN_DST_RIGHT	*Right Channel Send
0x0012	CONN_DST_CENTER	*Center Channel Send
0x0013	CONN_DST_LFE_CHANNEL	*LFE Channel Send
0x0014	CONN_DST_LEFTREAR	*Left Rear Channel Send
0x0015	CONN_DST_RIGHTREAR	*Rt Rear Channel Send
0x0080	CONN_DST_CHORUS	Chorus Send
0x0081	CONN_DST_REVERB	Reverb Send

* Denotes optional 6-channel output

Modulator LFO Destinations

0x0104	CONN_DST_LFO_FREQUENCY	LFO Frequency
0x0105	CONN_DST_LFO_STARTDELAY	LFO Start Delay Time

Vibrato LFO Destinations

0x0114	CONN_DST_VIB_FREQUENCY	Vibrato Frequency
0x0115	CONN_DST_VIB_STARTDELAY	Vibrato Start Delay

EG Destinations

0x0206	CONN_DST_EG1_ATTACKTIME	EG1 Attack Time
0x0207	CONN_DST_EG1_DECAYTIME	EG1 Decay Time
0x0208	CONN_DST_EG1_RESERVED	EG1 Reserved
0x0209	CONN_DST_EG1_RELEASETIME	EG1 Release Time
0x020A	CONN_DST_EG1_SUSTAINLEVEL	EG1 Sustain Level
0x020B	CONN_DST_EG1_DELAYTIME	EG1 Delay Time
0x020C	CONN_DST_EG1_HOLDTIME	EG1 Hold Time
0x020D	CONN_DST_EG1_SHUTDOWNTIME	EG1 Shutdown Time
0x030A	CONN_DST_EG2_ATTACKTIME	EG2 Attack Time
0x030B	CONN_DST_EG2_DECAYTIME	EG2 Decay Time
0x030C	CONN_DST_EG2_RESERVED	EG2 Reserved
0x030D	CONN_DST_EG2_RELEASETIME	EG2 Release Time
0x030E	CONN_DST_EG2_SUSTAINLEVEL	EG2 Sustain Level
0x030F	CONN_DST_EG2_DELAYTIME	EG2 Delay Time
0x0310	CONN_DST_EG2_HOLDTIME	EG2 Hold Time

Filter Destinations

0x0500	CONN_DST_FILTER_CUTOFF	Filter Cutoff Frequency
0x0501	CONN_DST_FILTER_Q	Filter Resonance

Transforms

0x0000	CONN_TRN_NONE	No Transform
0x0001	CONN_TRN_CONCAVE	Concave Transform
0x0002	CONN_TRN_CONVEX	Convex Transform
0x0003	CONN_TRN_SWITCH	Switch Transform

2.11 <wlnk-ck>, Wave Link Chunk

The <wlnk-ck> specifies where the wave data can be found for an instrument region in a DLS stream. The <wlnk-ck> is defined as follows:

```
<wlnk-ck>    →    wlnk(
                  <fusOptions:USHORT>
                  <usPhaseGroup:USHORT>
                  <ulChannel:ULONG>
                  <ulTableIndex:ULONG>
                  )
```

The <wlnk-ck> chunk:

Field	Description																																						
fusOptions	Specifies flag options for this wave link. All bits not defined must be set to 0. The define flags are as follows: <table border="0" style="margin-left: 20px;"> <tr> <td>F_WAVELINK_PHASE_MASTER</td> <td style="text-align: right;">0x0001</td> </tr> <tr> <td colspan="2">Specifies that this link is the master in a group of phase locked wave links.</td> </tr> <tr> <td>F_WAVELINK_MULTICHANNEL</td> <td style="text-align: right;">0x0002</td> </tr> <tr> <td colspan="2">Indicates that the <i>ulChannel</i> field provides the channel steering information and all the channel steering data in the articulation chunk should be ignored.</td> </tr> </table>	F_WAVELINK_PHASE_MASTER	0x0001	Specifies that this link is the master in a group of phase locked wave links.		F_WAVELINK_MULTICHANNEL	0x0002	Indicates that the <i>ulChannel</i> field provides the channel steering information and all the channel steering data in the articulation chunk should be ignored.																															
F_WAVELINK_PHASE_MASTER	0x0001																																						
Specifies that this link is the master in a group of phase locked wave links.																																							
F_WAVELINK_MULTICHANNEL	0x0002																																						
Indicates that the <i>ulChannel</i> field provides the channel steering information and all the channel steering data in the articulation chunk should be ignored.																																							
usPhaseGroup	Specifies a group number for samples which are phase locked. All waves in a set of wave links with the same group are phase locked and follow the wave in the group with the F_WAVELINK_PHASE_MASTER flag set. If a wave is not a member of a phase locked group, this value should be set to 0.																																						
ulChannel	Specifies the channel placement of the sample. This is used to place mono sounds within a stereo pair or for multi-track placement. Each bit position within the <i>ulChannel</i> field specifies a channel placement with bit 0 specifying a mono sample or the left channel of a stereo file. Bit assignments are as follows: <table border="0" style="margin-left: 20px;"> <tr><td>0</td><td>Left (or mono)</td></tr> <tr><td>1</td><td>Right Channel</td></tr> <tr><td>2</td><td>Center</td></tr> <tr><td>3</td><td>Low Frequency Energy</td></tr> <tr><td>4</td><td>Surround Left</td></tr> <tr><td>5</td><td>Surround Right</td></tr> <tr><td>6</td><td>Left of Center</td></tr> <tr><td>7</td><td>Right of Center</td></tr> <tr><td>8</td><td>Surround Center</td></tr> <tr><td>9</td><td>Side Left</td></tr> <tr><td>10</td><td>Side Right</td></tr> <tr><td>11</td><td>Top</td></tr> <tr><td>12</td><td>Top Front Left</td></tr> <tr><td>13</td><td>Top Front Center</td></tr> <tr><td>14</td><td>Top Front Right</td></tr> <tr><td>15</td><td>Top Rear Left</td></tr> <tr><td>16</td><td>Top Rear Center</td></tr> <tr><td>17</td><td>Top Rear Right</td></tr> <tr><td>18-31</td><td>Reserved (DO NOT USE)</td></tr> </table>	0	Left (or mono)	1	Right Channel	2	Center	3	Low Frequency Energy	4	Surround Left	5	Surround Right	6	Left of Center	7	Right of Center	8	Surround Center	9	Side Left	10	Side Right	11	Top	12	Top Front Left	13	Top Front Center	14	Top Front Right	15	Top Rear Left	16	Top Rear Center	17	Top Rear Right	18-31	Reserved (DO NOT USE)
0	Left (or mono)																																						
1	Right Channel																																						
2	Center																																						
3	Low Frequency Energy																																						
4	Surround Left																																						
5	Surround Right																																						
6	Left of Center																																						
7	Right of Center																																						
8	Surround Center																																						
9	Side Left																																						
10	Side Right																																						
11	Top																																						
12	Top Front Left																																						
13	Top Front Center																																						
14	Top Front Right																																						
15	Top Rear Left																																						
16	Top Rear Center																																						
17	Top Rear Right																																						
18-31	Reserved (DO NOT USE)																																						
ulTableIndex	Specifies the 0 based index of the cue entry in the wave pool table.																																						

To create a group of phase-locked samples, the *usPhaseGroup* field of each <wlnk-ck> chunk must be set to the same value, which must be non-zero. Additionally, the F_WAVELINK_PHASE_MASTER bit must be set in one, and only one, of the <wlnk-ck> chunks, which will act as the master for all phase-locked samples.

When using phase-locked samples, all oscillators take their frequency from the oscillator associated with the phase-master sample. All parameters that can affect the frequency of a slaved oscillator *must be ignored*. This includes any connections with *ulDestination* set to DST_PITCH, as well as sample rate and fine tuning parameters in the <wsmp-ck> chunk. All slaved oscillators must play back at the frequency of the master oscillator and must retain sample lock to within plus or minus one half-sample at the device sample output rate.

When the F_WAVELINK_MULTICHANNEL bit is set, the channel assignment of a given sample is fixed, overriding any parameters in the articulation data. This allows for steering of data to specific speaker locations without regard to pan controls or other sends. When the F_WAVELINK_MULTICHANNEL bit is zero, channel assignment is not fixed, allowing for dynamic assignment of the channel via articulation data. Multichannel mode is optional, and DLS Level 2 devices need not support it. Content intended to be cross-platform compatible *must* not use the multichannel mode, unless the <wlnk-ck> is guarded through the use of a conditional chunk to protect it from DLS Level 2 devices that may not support multichannel playback.

2.12 <wsmp-ck>, Wave Sample Chunk

The <wsmp-ck> wave sample chunk describes the minimum necessary information needed to allow a synthesis engine to use a <wave-list> wave file chunk. The <wsmp-ck> is defined as follows:

```

<wsmp-ck>    →    wsmp(
                    <cbSize:ULONG>
                    <usUnityNote:USHORT>
                    <sFineTune:SHORT>
                    <lGain:LONG>
                    <fulOptions:ULONG>
                    <cSampleLoops:ULONG>
                    <wavesample-loop>...
                )

<wavesample-loop> → struct
                    {
                        ULONG  cbSize;
                        ULONG  ulLoopType;
                        ULONG  ulLoopStart;
                        ULONG  ulLoopLength;
                    }
    
```

The <wsmp-ck> chunk:

Field	Description
cbSize	Specifies the size of the structure in bytes. <i>This size does not include the loop records</i> . This field is needed to distinguish the amount of data in the structure versus the list of loops and allow for additions to this structure in the future. This cannot be determined from the chunk size.
usUnityNote	Specifies the MIDI note which will replay the sample at original pitch. This value ranges from 0 to 127 (a value of 60 represents Middle C, as defined by the MIDI specification).
sFineTune	Specifies the tuning offset from the usUnityNote in 16 bit relative pitch.
lGain	Specifies the gain to be applied to this sample in 32 bit relative gain units.
fulOptions	Specifies flag options for the digital audio sample. Current options are:

F_WSMP_NO_TRUNCATION 0x0001

This option specifies that a synthesis engine is not allowed to truncate the bit depth of the sample if it cannot synthesize at the bit depth of the digital audio. If the NO_TRUNCATION bit is set, the device is not allowed to truncate the data to a bit depth less than that of the original sample. Note that, if truncation is disallowed, the wave may take up more memory in the device and thus may fail to download due to memory constraints. If the bit is clear, the synthesis engine may truncate the bit depth, if required.

F_WSMP_NO_COMPRESSION 0x0002

This option specifies that a synthesis engine is not allowed to use compression in its internal synthesis engine for the digital audio sample. If the NO_COMPRESSION bit is set, the device is not allowed to compress the data. Note that, if compression is disallowed, the wave may take up more memory in the device and thus may fail to download due to memory constraints. If the bit is clear, the synthesis engine may compress the digital audio samples, if required.

cSampleLoops Specifies the number (count) of <wavesample-loop> records that are contained in the <wsmp-ck> chunk. The <wavesample-loop> records are stored immediately following the **cSampleLoops** data field. One shot sounds will have the **cSampleLoops** field set to 0. Looped sounds will have the **cSampleLoops** field set to 1. Values greater than 1 are not yet defined at this time.

The <wavesample-loop> structure:

Field	Description
cbSize	Specifies the size of the structure in bytes.
ulLoopType	Specifies the loop type: WLOOP_TYPE_FORWARD 0x0000 Forward Loop WLOOP_TYPE_RELEASE 0x0001 Loop and Release
ulLoopStart	Specifies the start point of the loop in samples as an absolute offset from the beginning of the data in the <data-ck> subchunk of the <wave-list> wave file chunk.
ulLoopLength	Specifies the length of the loop in samples.

2.13 <ptbl-ck>, Pool Table Chunk

The <ptbl-ck> pool table chunk contains a list of cross-reference entries to digital audio data within the wave pool. The <ptbl-ck> is defined as follows:

```

<ptbl-ck>  →  ptbl(
                <cbSize:ULONG>
                <cCues:ULONG>
                <poolcues(s)>...
            )

<poolcue>  →  struct
                {
                ULONG ulOffset;
                }
    
```

The <ptbl-ck> chunk:

Field	Description
cbSize	Specifies the size of the structure in bytes. <i>This size does not include the poolcue records.</i> This field is needed to distinguish the amount of data in the structure versus the list of cues and allow for additions to this structure in the future. This cannot be determined from the chunk size.
cCues	Specifies the number (count) of <poolcue> records that are contained in the <ptbl-ck> chunk. The <poolcue> records are stored immediately following the cCues data field.
ulOffset	Specifies the absolute offset in bytes from the beginning of the wave pool data to the correct entry in the wave pool. By using an offset to the data of each pool entry, a synthesis engine does not have to walk from the beginning of the list to find any given set of wave data but can immediately seek to the correct location in the wave pool chunk. Additions and deletions of entries in the wave pool need only modify the pool table as opposed to modifying every <wave-link> in the instrument chunks.

2.14 <vers-ck>, Version Chunk

The <vers-ck> defines an optional version stamp within a collection. The version stamp is intended primarily as a mechanism for managing DLS resources, in particular when installing DLS files. It indicates the version of the contents of the file, *not the DLS specification level*. A setup program reads the version chunk in a previously installed DLS file to identify whether it should install a newer file over it. The version stamp follows the same four number format as the version stamps used in executable code (.exe and .dll files). It is left to the discretion of the DLS file author to assign a version number scheme to a file.

The <vers-ck> is defined as follows:

```
<vers -ck>    →    vers(
                    <dwVersionMS:DWORD>
                    <dwVersionLS:DWORD >
                    )
```

The <vers -ck> chunk:

Field	Description
dwVersionMS	Specifies the high-order 32 bits of the binary version number for the file. The value of this member is used with the value of the dwVersionLS member to form a 64-bit version number. This 32 bit value can be further broken down with HIWORD(dwVersionMS) and LOWORD(dwVersionMS) to get two 16 bit values (version info is actually 4 16 bit values).
dwVersionLS	Specifies the low-order 32 bits of the binary version number for the file. The value of this member is used with the dwVersionMS value to form a 64-bit version number. Use HIWORD(dwVersionLS) and LOWORD(dwVersionLS) to extract the sixteen bit values.

The version chunk is essentially borrowed from the dwFileVersionMS and dwFileVersionLS fields in the Microsoft® VS_FIXEDFILEINFO structure which is used to store version information in .exe and .dll files. As such, the version can be broken down into four segments: the high and low words of the MS and the high and low words of the LS. For example, "VERSION 3,10,0,61" is translated into: dwVersionMS = 0x0003000a and dwVersionLS = 0x0000003d.

A <vers-ck> version chunk is typically (but not necessarily) near the top of the enclosing DLS chunk so it can be quickly found by installation software.

2.15 <INFO-list>, INFO List Chunk

The INFO list is a registered global form type that can store information that helps identify the contents of the chunk. This information is useful but does not affect the way a program interprets the file; examples are copyright information and comments. An INFO list is a LIST chunk with list type INFO. The following shows a sample INFO list chunk:

```
< INFO-list >      →      LIST(  'INFO'  [<info_text-ck>]...)
```

Example:

```
< INFO-list >      →      LIST(  'INFO'
                               INAM("Distorted Tuba"Z)
                               ICMT("The tuba meets Eddie Van Halen"Z)
                               )
```

An INFO list should contain only the following chunks. New chunks may be defined, but an application should ignore any chunk it doesn't understand. The chunks listed below may only appear in an INFO list. Each chunk contains a ZSTR, or null-terminated text string.

The <info_text-ck> chunks include:

Chunk ID	Description
IARL	Archival Location. Indicates where the subject of the file is archived.
IART	Artist. Lists the artist of the original subject of the file. For example, Les Paul.
ICMS	Commissioned. Lists the name of the person or organization that commissioned the subject of the file. For example, Pope Julian II.
ICMT	Comments. Provides general comments about the file or the subject of the file. If the comment is several sentences long, end each sentence with a period. Do not include newline characters.
ICOP	Copyright. Records the copyright information for the file. For example, Copyright Encyclopedia International 1991. If there are multiple copyrights, separate them by a semicolon followed by a space.
ICRD	Creation date. Specifies the date the subject of the file was created. List dates in year-month-day format, padding one-digit months and days with a zero on the left. For example, 1553-05-03 for May 3, 1553.
IENG	Engineer. Stores the name of the engineer who worked on the file. If there are multiple engineers, separate the names by a semicolon and a blank. For example, Smith, John; Adams, Joe.
IGNR	Genre. Describes the original work, such as, jazz, classical, rock, techno, rave, neo british pop grunge metal, etc.
IKEY	Keywords. Provides a list of keywords that refer to the file or subject of the file. Separate multiple keywords with a semicolon and a blank. For example, FX; death; murder.
IMED	Medium. Describes the original subject of the file, such as, record, CD, and so forth.
INAM	Name. Stores the title of the subject of the file, such as, Seattle From Above.
IPRD	Product. Specifies the name of the title the file was originally intended for, such as World Ruler V.
ISBJ	Subject. Describes the contents of the file, such as Music of the New World Order.
ISFT	Software. Identifies the name of the software package used to create the file, such as Sonic Foundry Sound Forge.

- ISRC** Source. Identifies the name of the person or organization who supplied the original subject of the file. For example, Trey Research.
- ISRF** Source Form. Identifies the original form of the material that was digitized, such as record, sampling CD, TV sound track, and so forth. This is not necessarily the same as IMED.
- ITCH** Technician. Identifies the technician who sampled the subject file. For example, Smith, John.

2.16 DLS Wave File Format

The <wave-list> wave file chunk is defined as follows. **Programs must expect (and ignore) any unknown chunks encountered, as with all RIFF forms.** However, <fmt-ck> must always occur before <data-ck>, and both <fmt-ck> and <data-ck> chunks are mandatory in a <wave-file>.

A <wave-list> is similar to an embedded wave file, as would be generated by a wave editing program. These wave file chunks are referenced from the <rgn-list> chunks inside each <ins-list> chunk, and accessed via the <poolcue> entries in the <ptbl-ck> pool table chunk. The <wave-list> data is equivalent to that found in a normal <WAVE-form> WAV file, with two exceptions. First, the initial three DWORD values in a normal <WAVE-form> WAV file (which are 'RIFF' [size] 'WAVE') are replaced with a <wave-list> chunk header ('LIST' [size] 'wave'). Second, an optional <dlid-ck> is inserted as the first element following the <wave-list> chunk header, in order to provide a globally unique identifier for the <wave-list> wave file data.

DLS does not require the use of <fact-ck>, <cue-ck>, <playlist-ck> or <assoc-data-list> chunks; therefore, they are intentionally left out of the specification.

```

<wave-list>  →      LIST( 'wave' // note: 'wave' is lower case
                    [<dlid-ck>]
                    <fmt-ck>
                    [<wsmp-ck>]
                    [<fact-ck>]
                    [<cue-ck>]
                    [<playlist-ck>]
                    [<assoc-data-list>]
                    [<INFO-list>]
                    <data-ck>
                    )
    
```

2.16.1 Format Chunk <fmt-ck>

The WAVE format chunk <fmt-ck> specifies the format of the <wave-data>. The <fmt-ck> is defined as follows:

```

<fmt-ck>      →      fmt ( <common-fields>
                          <format-specific-fields>
                          )

<format-specific-fields>  →      <PCM-format-specific>
                                // only valid format for DLS Level 1

<PCM-format-specific>    →      struct {
                                WORD   wBitsPerSample;
                                }

<common-fields>         →      struct {
                                WORD   wFormatTag;
                                WORD   wChannels;
                                DWORD  dwSamplesPerSec;
                                DWORD  dwAvgBytesPerSec;
                                WORD   wBlockAlign;
                                }
    
```

The <PCM-format-specific> chunk:

Field	Description
wBitsPerSample	Specifies the number of bits of data used to represent each sample of each channel. If there are multiple channels, the sample size is the same for each channel. DLS level 1 supports only 8 or 16 bit samples.

The <common-fields> chunk:

Field	Description
wFormatTag	A number indicating the WAVE format category of the file. The content of the <format-specific-fields> portion of the fmt chunk, and the interpretation of the waveform data, depend on this value. DLS Level 1 only supports WAVE_FORMAT_PCM (0x0001) Microsoft Pulse Code Modulation (PCM) format.
wChannels	The number of channels represented in the waveform data, such as 1 for mono or 2 for stereo. DLS Level 1 supports only mono data (value = "1").
dwSamplesPerSec	The sampling rate (in samples per second) at which each channel should be played.
dwAvgBytesPerSec	The average number of bytes per second at which the waveform data should be transferred. Playback software can estimate the buffer size using this value.
wBlockAlign	The block alignment (in bytes) of the waveform data. Playback software needs to process a multiple of wBlockAlign bytes of data at a time, so the value of wBlockAlign can be used for buffer alignment.

2.16.2 Data Chunk <data-ck>

The <data-ck> contains the waveform data. It is defined as follows:

```
<data-ck>    →    data( <wave-data> )
```

The <data-ck> chunk:

Field	Description
<wave-data>	This is the PCM wave data. See Data Packing for WAVE_FORMAT_PCM Files and Data Format of the WAVE_FORMAT_PCM Samples sections

2.16.3 Data Packing for WAVE_FORMAT_PCM Files

In a single-channel <wave-file>, samples are stored consecutively. For stereo <wave-file>, channel 0 represents the left channel, and channel 1 represents the right channel. The speaker position mapping for more than two channels is currently undefined. In multiple-channel <wave-file>, samples are interleaved. Only channel 0 is supported for DLS Level 1 and Level 2. Stereo file format are shown for completeness.

The following diagrams show the data packing for a 8-bit mono and stereo WAVE files:

2.16.4 Data Packing for 8-Bit Mono PCM

Sample 1	Sample 2	Sample 3	Sample 4
Channel 0	Channel 0	Channel 0	Channel 0

2.16.5 Data Packing for 8-Bit Stereo PCM

Sample 1	Sample 1	Sample 2	Sample 2
Channel 0	Channel 1	Channel 0	Channel 0
(left)	(right)	(left)	(right)

The following diagrams show the data packing for 16-bit mono and stereo WAVE files:

2.16.6 Data Packing for 16-Bit Mono PCM

Sample 1	Sample 1	Sample 2	Sample 2
Channel 0	Channel 0	Channel 0	Channel 0
low-order	high-order	low-order	high-order
byte	byte	byte	byte

2.16.7 Data Packing for 16-Bit Stereo PCM

Sample 1	Sample 1	Sample 1	Sample 1
Channel 0	Channel 0	Channel 1	Channel 1
(left)	(left)	(right)	(right)
low-order	high-order	low-order	high-order
byte	byte	byte	byte

2.16.8 Data Format of the WAVE_FORMAT_PCM Samples

The data format and maximum and minimums values for PCM waveform samples of various sizes are as follows:

Sample Size	Data Format	Maximum Value	Minimum Value	Midpoint Value
8 bit	Unsigned	255 (0xFF)	0	128 (0x80)
16 bit	Signed	32767 (0x7FFF)	-32768 (0x8000)	0

2.17 Instrument Object Hierarchy

The following charts show how the instrument object hierarchies described in the DLS Device Architecture specification correspond to particular chunks within the <DLS-form> file.

Object Hierarchy: Level 1 Melodic Instrument

Melodic Instrument-----
 Global
 Connection Blocks-----
 Region (1..16)-----
 Wave Link-----
 Wave Sample-----
 Wave File-----
 Wave Sample (optional)-----
 Wave Data-----

Corresponding <DLS-form> chunks

<ins-list> instrument, <insh-ck> instrument header, <INFO-list>
 <Iart-list> list of articulators
 <art1-ck> articulator
 <Irgn-list> list of regions, holding <rgn-list> region chunks
 <wlnk-ck> wave link
 <wsmp-ck> wave sample
 <wave-list> wave file
 <wsmp-ck> wave sample
 <data-ck>

Object Hierarchy: Level 1 Drum Kit

Drum Kit-----
 Region (1..128)-----
 Wave Link-----
 Wave Sample-----
 Wave File-----
 Wave Sample (optional)-----
 Wave Data-----
 Region Articulation-----
 Connection Blocks-----

Corresponding <DLS-form> chunks

<ins-list> instrument, <insh-ck> instrument header, <INFO-list>
 <Irgn-list> list of regions, holding <rgn-list> region chunks
 <wlnk-ck> wave link
 <wsmp-ck> wave sample
 <wave-list> wave file
 <wsmp-ck> wave sample
 <data-ck>
 <Iart-list> list of articulators
 <art1-ck> articulator

Object Hierarchy: Level 2 Instrument

Instrument-----
 Global
 Connection Blocks-----
 Region (1..n)
 Wave Link-----
 Wave Sample-----
 Wave File-----
 Wave Sample (optional)-----
 Wave Data-----
 Region Articulation-----
 Connection Blocks-----

Corresponding <DLS-form> chunks

<ins-list> instrument, <insh-ck> instrument header, <INFO-list>
 <Iart-list>,<Iar2-list> list of articulators
 <art1-ck>,<art2-ck> articulator
 <Irgn-list> list of <rgn-list>,<rgn2-list> region chunks
 <wlnk-ck> wave link
 <wsmp-ck> wave sample
 <wave-list> wave file
 <wsmp-ck> wave sample
 <data-ck>
 <Iart-list>,<Iar2-list> list of articulators
 <art1-ck>,<art2-ck> articulator

2.18 Proprietary Chunk IDs

In addition to the use of Conditional Chunks for adding proprietary features, manufacturers of DLS devices may embed product-specific data into a DLS file using a Proprietary Chunk ID. These IDs are assigned exclusively by the MMA, in order to prevent any potential error or conflicts between manufacturers accidentally using the same ID. Manufacturers wishing to obtain their own Proprietary Chunk ID should visit the MMA web site (www.midi.org) or contact the MMA for an application form.

Proprietary Chunk IDs work as follows:

- The ID is alpha-numeric and 4 bytes in length.
- The first three digits are assigned by the MMA. Manufacturers may receive three digits of their own choosing, if available and approved by the MMA. (Some choices are reserved).
- The fourth digit is assigned by the manufacturer, and should indicate a specific product (or product group with consistent features).
- Allowable characters are A-Z and 0-9, supporting 36 different products or product groups.
- Manufacturers needing more variations may apply for an additional ID.

2.19 File Examples

2.19.1 Generic DLS Level 1 File

This instrument collection contains two instruments, an ocean surf sound and a flute instrument. The ocean surf is loaded in bank 1 instrument 1 and responds across the whole key range. The flute sound is loaded in bank 1 instrument 2 and consists of two regions with one region for keys from 0-63 and one region for keys from 64-127.

```

RIFF 'DLS '
  <vers>      (1,0,0,23)
  LIST 'INFO'
    inam "Demo Collection with Ocean Surf and Flute"
    icop "Copyright © 1996 MIDI Manufacturers Association"
  <dclid> (globally unique identifier for entire collection)
  <colh> (2 Instruments in this collection)
  LIST 'lins'
    LIST 'ins '
      LIST 'INFO'
        inam "Ocean Surf"
      <dclid> (globally unique identifier for "Ocean Surf" instrument)
      <insh> (1 Region, location bank 5600h instrument 1)
      LIST 'lrgn'
        LIST 'rgn '
          <rgnh> ( responds to all keys from 0-127, velocities from 0-127)
          <wsmp> (specifies loop points and midi root note)
          <wlnk>      (specifies Wave #1 (index = 0) in the Pool Table)
        LIST 'lart'
          <art1> (specifies the Level 1 articulation for this instrument)
      LIST 'ins '
        LIST 'INFO'
          inam "My Flute"
        <dclid> (globally unique identifier for "My Flute" instrument)
        <insh> (2 Regions, location bank 5600h instrument 2)
        LIST 'lrgn'
          LIST 'rgn '
            <rgnh> ( responds to all keys from 0-63, velocities from 0-127)
            <wsmp> (specifies loop points and midi root note)
            <wlnk>      (specifies Wave #2 (index= 1) in the Pool Table)
          LIST 'rgn '
            <rgnh> ( responds to all keys from 64-127, velocities from 0-127)
            <wsmp> (specifies loop points and midi root note)
            <wlnk>      (specifies Wave #3 (index = 2) in the Pool Table)

```

LIST 'Iart'

<art1> (specifies the Level 1 articulation for this instrument)

<ptbl> [3 entries, [0,offset to surf][1,offset to flute lower][2,offset to flute upper]]

LIST 'wvpl'

LIST 'wave' (Ocean surf sound)

<dclid> (globally unique identifier for "Ocean Surf" wave file)

LIST 'wave' (Flute for lower half of keyboard)

<dclid> (globally unique identifier for lower-register flute wave file)

LIST 'wave' (Flute for upper half of keyboard)

<dclid> (globally unique identifier for upper-register flute wave file)

2.19.2 DLS Level 1 File With 3rd Party Extensions

The following example shows the exact same file but with additional **Proprietary Chunks** embedded for a more complex synthesis engine. The file is still compatible with DLS Level 1. The additional chunks embedded in this case are all assigned to manufacturer ID "MMA", and used as follows:

<MMAx> A third party effect chunk which contains parameters for overall effects which can be applied to a full collection of instruments.

<MMAI> A third party articulation chunk which specifies parameters which can be applied to each instrument in a collection, or each region within an instrument, depending on where the chunk is located in the DLS file structure. Since the chunk appears at different locations, the same ID may be used.

<MMA2> Another third party articulation chunk but intended for a different DLS device from manufacturer "MMA". Since this is the second proprietary chunk to be used at the same level, it must have a unique ID.

RIFF 'DLS '

LIST 'INFO'

inam "Demo Collection with Ocean Surf and Flute"

icop "Copyright © 1996 MIDI Manufacturers Association"

<dclid> (globally unique identifier for entire collection)

<colh> (2 Instruments in this collection)

LIST 'lins'

LIST 'ins '

LIST 'INFO'

inam "Ocean Surf"

<dclid> (globally unique identifier for "Ocean Surf" instrument)

<insh> (1 Region, location bank 5600h instrument 1)

LIST 'lrgn'

LIST 'rgn '

<rgnh> (responds to all keys from 0-127, velocities from 0-127)

<wsmp> (specifies loop points and midi root note)

DOWNLOADABLE SOUNDS LEVEL 2.1

<wlnk> (specifies Wave #1 (index = 0) in the Pool Table)
LIST 'lart'
<MMA1> (specifies 3rd party region level articulation)

LIST 'lart'
<art1> (specifies the Level 1 articulation for this instrument)
<MMA1> (specifies 3rd party instrument level articulation)

LIST 'ins '

LIST 'INFO'
inam "My Flute"
<dldid> (globally unique identifier for "My Flute" instrument)
<insh> (2 Regions, location bank 5600h instrument 2)

LIST 'lrgn'

LIST 'rgn '
<rgnh> (responds to all keys from 0-63, velocities from 0-127)
<wsmp> (specifies loop points and midi root note)
<wlnk> (specifies Wave #2 (index = 1) in the Pool Table)
LIST 'lart'
<MMA2> (specifies 3rd party region level articulation device)

LIST 'rgn '
<rgnh> (responds to all keys from 64-127, velocities from 0-127)
<wsmp> (specifies loop points and midi root note)
<wlnk> (specifies Wave #3 (index = 2) in the Pool Table)
LIST 'lart'
<MMA1> (specifies 3rd party region level articulation)

LIST 'lart'
<art1> (specifies the Level 1 articulation for this instrument)
<MMA1> (specifies 3rd party instrument level articulation)

<ptbl> [3 entries, [0,offset to surf][1,offset to flute lower][2,offset to flute upper]]

LIST 'wvpl'

LIST 'wave' (Ocean surf sound)
<dldid> (globally unique identifier for "Ocean Surf" wave file)

LIST 'wave' (Flute for lower half of keyboard)
<dldid> (globally unique identifier for lower-register flute wave file)

LIST 'wave' (Flute for upper half of keyboard)
<dldid> (globally unique identifier for upper-register flute wave file)

<MMA1> (specifies 3rd party effects for the complete collection)

2.19.3 Generic DLS Level 2 File

This instrument collection contains a Strings and Bell layer instrument. The strings stretch from MIDI note 21 to 108, and contain two velocity splits, while the bell layer plays only from MIDI note 60 to 108.

```

RIFF 'DLS '
  <vers>      (2,1,3,15)
  LIST 'INFO'
    inam "Demo Strings plus Bell Pad"
    icop "Copyright © 1998 MIDI Manufacturers Association"
  <dldid> (globally unique identifier for entire collection)
  <colh> (1 Instrument in this collection)
  LIST 'lins'
    LIST 'ins '
      LIST 'INFO'
        inam "Strings plus Bell Pad"
        <dldid> (globally unique identifier for "Strings plus Bell Pad" instrument)
        <insh> (3 Regions, location bank 0100h instrument 1)
      LIST 'lar2'
        <art2> (specifies the Level 2 articulation for this instrument)
      LIST 'lrgn'
        LIST 'rgn2'
          <rgnh> ( responds to all keys from 21-108, velocities from 0-63)
          <wsmp> (specifies loop points and midi root note)
          <wlnk> (specifies Wave #1 (index = 0) in the Pool Table)
        LIST 'lar2'
          <art2> (specifies the Level 2 articulation for this region)
        LIST 'rgn2'
          <rgnh> ( responds to all keys from 21-108, velocities from 64-127)
          <wsmp> (specifies loop points and midi root note)
          <wlnk> (specifies Wave #1 (index = 0) in the Pool Table)
        LIST 'lar2'
          <art2> (specifies the Level 2 articulation for this region)
    <ptbl> [3 entries, [0,offset to strings vel 0-63][1, offset to strings vel 64-127][2,offset to bell]]
  LIST 'wvpl'
    LIST 'wave' (String velocity layer 0-63)
      <dldid> (globally unique identifier for "Strings" layer 0-63 wave file)
    LIST 'wave' (String velocity layer 64-127)
      <dldid> (globally unique identifier for "Strings" layer 64-127 wave file)
    LIST 'wave' (Bell sample for layer)
      <dldid> (globally unique identifier for "Bell" layer wave file)

```

3. Compatibility Notes

3.1 Coding Requirements and Recommendations

When writing code to read and write DLS files, it is imperative that the programmer takes into account the following:

- Since this is an expandable format, DLS file parsers must be able to ignore and correctly skip unrecognized chunks in a DLS file. This is standard practice for RIFF files but is extremely important with the DLS format since one of its purposes is to allow manufacturers to embed proprietary chunks which exploit advanced features of their synthesis engines.
- Ordering of chunks within the file format should not be assumed. For instance, a programmer should not assume that within a <rgn-list> instrument region, chunks will always appear in the order of <rgnh-ck>, <wsmp-ck>, <wlnk-ck>, <lart-list>. They may actually appear in any order within the list.
- If a <wsmp-ck> does not exist in a region list, the synthesis engine will use the <wsmp-ck> found in the referenced wave data. If a <wsmp-ck> exists in a region list, its values are used instead of any found in the referenced wave data. If a <wsmp-ck> exists in neither the region list nor the referenced data, then default values are used. These are One shot Sound, with a MIDI Unity note of 60 (Middle C), no attenuation, and no fine tune.
- Connections that are implied by the DLS device architecture must not be written to the DLS file. Implied connections include: MIDI Note to Key, RPN2 to Key, MIDI Controller 7 to Gain, MIDI Controller 11 to Gain, MIDI Controller 10 to Pan, EG1 to Attenuation, Pitch Wheel RPN0 to Pitch.
- Applications modifying the voice allocation mode should reset the DLS device to the default (static MIDI channel priority) upon exiting to insure predictable polyphony.

3.2 DLS Level 1 and Level 2 Compatibility

The following restrictions are placed upon the file format and must be followed for DLS Level 1 and Level 2 compatibility:

- For the <wlnk-ck> wave link the only allowed type for the **ulChannel** field is WAVELINK_CHANNEL_LEFT. This means that for a DLS Level 1 file only mono sound data is allowed. **fusOptions**, **usPhase Group** and other values for **ulChannel** other than **ulChannel = WAVELINK_CHANNEL_LEFT** should be set to default values since these fields are optional and are not required to be supported in DLS Level 1.
- For the embedded wave files <wave-list> within the <wvpl-list> the only data format allowed is WAVE_FORMAT_PCM. The files also must be 8 or 16 bit mono files. This means that only mono files which are 8 or 16 bit PCM data are allowed for DLS Level 1 and Level 2. See Section 5 for more details on the wave format.
- For the <rgnh-ck> the allowed key groupings for the **ulKeyGroup** field are 0 for no key grouping and 1-15 for key groupings. This means there are 15 allowable key groupings within an instrument.
- Some DLS devices support playback rates of only 22.05 kHz. To prevent samples from aliasing on these devices, it is recommended that samples for these devices be restricted to 22.05 kHz or below.
- 0dB is defined as the maximum output level at the Volume summing node (DST_GAIN, known as DST_ATTENUATION in DLS Level 1). If a sound designer exceeds 0dB, the output level will be clipped to 0dB.

3.3 DLS Level 1 Compatibility

The following restrictions are placed upon the file format and must be followed for DLS Level 1 compatibility. Additional information on how to code a mixed DLS Level 1 and Level 2 file may be found in the section on Conditional Chunks.

- For the <lrn-list> a maximum of 16 regions can exist for any given melodic instrument and 128 regions for a drum instrument.
- The *RangeVelocity* field is not supported by the DLS Level 1 specification, so all regions' *RangeVelocity* fields for a DLS Level 1 collection should be set to 0 for the *usLow* field and 127 for the *usHigh* field.
- DLS Level 1 regions are not allowed to overlap. This means that “splits” are supported by DLS Level 1 but “layers” are not. Therefore, an instrument's regions *RangeKey* field can not overlap.
- DLS Level 1 melodic instruments may have a single articulation data list <art-list> at the instrument level, which is the global articulation data for all regions.
- DLS Level 1 drum instruments may have local articulation data lists <art-list> for each region, but may not have global articulation data at the instrument level.
- To detect whether a given instrument is a drum or melodic instrument, a program should check the instrument header's **ulBank** field bit 31. If **ulBank** bit 31 is equal to 1, then the instrument is a drum instrument. If **ulBank** bit 31 is equal to 0, then the instrument is a melodic instrument. The distinction between drum and melodic instruments will cease to exist in a future revision of the DLS specification.
- For the <art1-ck> the **ulDefaultPan** field is only used when specifying articulation data for regions of Drum instruments. For melodic instruments this value should not be specified in the connection list.
- While all Level 1 devices will support the full +2/-4 octave transposition range, certain Level 1 devices have other limits on the transposition range. This limitation is imposed by available memory bandwidth and is determined by the number of voices playing and the amount of transposition occurring on each voice. The following formula may be applied to ensure that problems are not encountered with such devices: For each active voice, divide the playback frequency by the frequency at which the sample was recorded. The sum of the ratios of all active voices must be less than or equal to 36. For example, if you have 24 voices playing and each sample is being transposed up 7 semitones (~1.5 times the original frequency), the sum is $24 * 1.5 = 36$. However, if one of those voices was transposing up an octave (2 times the original frequency), the sum would be $23 * 1.5 + 2 = 36.5$, which would exceed the limitation of some Level 1 devices. Note that when calculating the transposition, you must consider the transposition that occurs as the sample is transposed from its root key, tuning fields in the sample header and articulation data, the Fine Tuning RPN, and any effects from Pitch Bend.
- Level 1 Devices do not support the use of the Coarse Tuning RPN on MIDI Channel 10.

3.4 Mod LFO to Gain Change (DLS 2.1)

Due to ambiguities in the DLS Level 1 specification, there were discrepancies in the implementation of the Mod LFO to Gain connection. The majority of DLS Level 1 synthesizers that have been deployed implement this connection as bipolar, non-inverted. However, the initial release of the DLS Level 2 specification requires a unipolar, inverted connection for Mod LFO to Gain, as well as for the Mod LFO CC1 to Gain and Mod LFO Channel Pressure to Gain connections. At the time of this writing, there has been no significant deployment of DLS Level 2 synthesizers, therefore, to facilitate backward compatibility, the DLS Level 2 specification has been revised to reflect the practices established by the majority of DLS Level 1 synthesizers. The DLS Level 2.1 implementation of Mod LFO to Gain will result in an increase of signal amplitude during the initial phase of the LFO, assuming a positive IScale value.

3.5 DLSID Integrity

The following requirements must be observed to maintain the integrity of DLSID Globally Unique Identifiers:

Support for DLSID Identifiers is optional, not required. However, a DLS implementation which does not support the use of DLSID Identifiers or the generation of new DLSID values must still observe several requirements. First, such implementations must be prepared to ignore and skip over any DLSIDs found within a DLS file, just as if the <dldid-ck> DLSID were an unrecognized chunk. Second, if such an implementation *modifies* a DLS file, it **must** remove any <dldid-ck> chunk found within the top-level <DLS-form> and any additional <dldid-ck> chunks found within the modified portions of the DLS file.

Leaving the unchanged <dldid-ck> chunks within the modified file would violate the DLSID “uniqueness” rule. Finally, when exporting a DLS wave file from a <DLS-form> collection to a raw <WAVE-form> wave file, any embedded <dldid-ck> chunks should be stripped out.

For implementations which **do** support the use of <dldid> DLSID chunks:

If an object has a DLSID associated with it, a new DLSID value *must* be generated whenever the associated object is modified. This includes changes to an <INFO-list> chunk. If an internal object, such as an instrument or wave is changed, one must change the DLSID for *both* the object (instrument or wave) *and* the enclosing <DLS-form> collection. Note that if <vers-ck> version chunks and <dldid-ck> identifiers are both used in the same file, changing the <vers-ck> requires a concurrent change to all associated <dldid-ck> values.

A DLS-aware utility which is importing a DLS object from one <DLS-form> collection into another <DLS-form> collection should not change the DLSID of the object being copied. In other words, if one is copying a <ins-list> or <wave-list> chunk from one <DLS-form> into another, one should *not* change the <dldid-ck> within the <ins-list> or <wave-list>, since this data is not being changed. Of course, one *must* change the collection DISID (the top-level <dldid-ck> within the target <DLS-form>), because importing an object into the collection changes that collection.

Wave files need special handling, since they are often generated or processed by applications which are not aware of DLSID chunks. A *raw* wave file is a stand-alone <WAVE-form> file, distinguished by the initial sequence 'RIFF'[size]'WAVE'. A *DLS* wave file is an embedded <wave-list> chunk, normally kept inside a <DLS-form> collection, distinguished by the initial sequence 'LIST'[size]'wave' (upper case vs. lower case is significant).

When importing a raw <WAVE-form> wave file into a <DLS-form> collection, generate and insert a new <dldid-ck> for the wave file (replacing any pre-existing <dldid-ck> within the raw wave file).

When exporting a DLS wave file from a <DLS-form> collection to a raw <WAVE-form> wave file, the embedded <dldid-ck> should be stripped out.

<u>FROM</u>	<u>TO</u>	<u>Comment</u>
<DLS-form>	<DLS-form>	Keep DLSID for instrument or wave file (data is unchanged) Change DLSID for target <DLS-form>
<WAVE-form> (raw wave file)	<DLS-form>	Remove pre-existing DLSID from raw wave file, if any Generate new DLSID for wave file object within DLS collection.
<DLS-form>	<WAVE-form>	Remove DLSID during export

It is recommended that each <dldid-ck> DLSID chunk should be placed as the *first* chunk within the enclosing LIST or FORM chunk, in order to facilitate searching. However, this ordering should not be assumed.

4. DLS Header Files

The following header files include defines and structures for DLS Level 1 and DLS Level 2 synthesizers. The DLS Level 2 header file augments the DLS Level 1 header file, and both must be included in any DLS Level 2 synthesizer implementation.

4.1 DLS Level 1 Header File

```

/*
    dls.h

    Description:

    Interface defines and structures for the Instrument Collection Form
    RIFF DLS.

    Written by Sonic Foundry 1996.  Released for public use.
*/

#ifndef __INC_DLS
#define __INC_DLS

/*
    Layout of an instrument collection:

    RIFF [] 'DLS ' [colh,INSTLIST,WAVEPOOL,INFOLIST]

    INSTLIST
    LIST [] 'lins'
            LIST [] 'ins ' [insh,RGNLIST,ARTLIST,INFOLIST]
            LIST [] 'ins ' [insh,RGNLIST,ARTLIST,INFOLIST]
            LIST [] 'ins ' [insh,RGNLIST,ARTLIST,INFOLIST]

    RGNLIST
    LIST [] 'lrgn'
            LIST [] 'rgn ' [rgnh,wsmp,wlnk,ARTLIST]
            LIST [] 'rgn ' [rgnh,wsmp,wlnk,ARTLIST]
            LIST [] 'rgn ' [rgnh,wsmp,wlnk,ARTLIST]

    ARTLIST
    LIST [] 'lart'
            'art1' level 1 Articulation connection graph
            'art2' level 2 Articulation connection graph
            '3rd1' Possible 3rd party articulation structure 1
            '3rd2' Possible 3rd party articulation structure 2 .... and so on

    WAVEPOOL
    ptbl [] [pool table]
    LIST [] 'wvpl'
            [path],
            [path],
            LIST [] 'wave',RIFFWAVE
            LIST [] 'wave',RIFFWAVE
            LIST [] 'wave',RIFFWAVE
            LIST [] 'wave',RIFFWAVE
            LIST [] 'wave',RIFFWAVE

```

DOWNLOADABLE SOUNDS LEVEL 2.1

```

INFOLIST
LIST [] 'INFO'
        'icmt' 'One of those crazy comments.'
        'icop' 'Copyright (C) 1996 Sonic Foundry'

*/

/*
    FOURCC's used in the DLS file
*/

#define FOURCC_DLS      mmioFOURCC('D','L','S',' ')
#define FOURCC_COLH    mmioFOURCC('c','o','l','h')
#define FOURCC_WVPL    mmioFOURCC('w','v','p','l')
#define FOURCC_PTBL    mmioFOURCC('p','t','b','l')
#define FOURCC_PATH    mmioFOURCC('p','a','t','h')
#define FOURCC_wave    mmioFOURCC('W','A','V','E')
#define FOURCC_LINS    mmioFOURCC('l','i','n','s')
#define FOURCC_INS     mmioFOURCC('i','n','s',' ')
#define FOURCC_INSH    mmioFOURCC('i','n','s','h')
#define FOURCC_LRGN    mmioFOURCC('l','r','g','n')
#define FOURCC_RGN     mmioFOURCC('r','g','n',' ')
#define FOURCC_RGNH    mmioFOURCC('r','g','n','h')
#define FOURCC_LART    mmioFOURCC('l','a','r','t')
#define FOURCC_ART1    mmioFOURCC('a','r','t','1')
#define FOURCC_WLNK    mmioFOURCC('w','l','n','k')
#define FOURCC_WSMP    mmioFOURCC('w','s','m','p')
#define FOURCC_VERS    mmioFOURCC('v','e','r','s')

/*
    Articulation connection graph definitions
*/

/* Generic Sources */
#define CONN_SRC_NONE          0x0000
#define CONN_SRC_LFO          0x0001
#define CONN_SRC_KEYONVELOCITY 0x0002
#define CONN_SRC_KEYNUMBER    0x0003
#define CONN_SRC_EG1          0x0004
#define CONN_SRC_EG2          0x0005
#define CONN_SRC_PITCHWHEEL   0x0006

/* Midi Controllers 0-127 */
#define CONN_SRC_CC1          0x0081
#define CONN_SRC_CC7          0x0087
#define CONN_SRC_CC10         0x008a
#define CONN_SRC_CC11         0x008b

/* Registered Parameter Numbers */
#define CONN_SRC_RPN0         0x0100
#define CONN_SRC_RPN1         0x0101
#define CONN_SRC_RPN2         0x0102

/* Generic Destinations */
#define CONN_DST_NONE          0x0000
#define CONN_DST_ATTENUATION   0x0001
#define CONN_DST_RESERVED     0x0002
#define CONN_DST_PITCH        0x0003
#define CONN_DST_PAN          0x0004

/* LFO Destinations */
#define CONN_DST_LFO_FREQUENCY 0x0104
#define CONN_DST_LFO_STARTDELAY 0x0105

```

DOWNLOADABLE SOUNDS LEVEL 2.1

```

/* EG1 Destinations */
#define CONN_DST_EG1_ATTACKTIME      0x0206
#define CONN_DST_EG1_DECAYTIME       0x0207
#define CONN_DST_EG1_RESERVED        0x0208
#define CONN_DST_EG1_RELEASETIME     0x0209
#define CONN_DST_EG1_SUSTAINLEVEL    0x020a

/* EG2 Destinations */
#define CONN_DST_EG2_ATTACKTIME      0x030a
#define CONN_DST_EG2_DECAYTIME       0x030b
#define CONN_DST_EG2_RESERVED        0x030c
#define CONN_DST_EG2_RELEASETIME     0x030d
#define CONN_DST_EG2_SUSTAINLEVEL    0x030e

#define CONN_TRN_NONE                 0x0000
#define CONN_TRN_CONCAVE              0x0001

typedef struct _DLSVERSION {
    DWORD    dwVersionMS;
    DWORD    dwVersionLS;
}DLSVERSION, FAR *LPDLSVERSION;

typedef struct _CONNECTION {
    USHORT   usSource;
    USHORT   usControl;
    USHORT   usDestination;
    USHORT   usTransform;
    LONG     lScale;
}CONNECTION, FAR *LPCONNECTION;

/* Level 1 Articulation Data */

typedef struct _CONNECTIONLIST {
    ULONG    cbSize;           /* size of the connection list structure */
    ULONG    cConnections;    /* count of connections in the list */
} CONNECTIONLIST, FAR *LPCONNECTIONLIST;

/*
Generic type defines for regions and instruments
*/

typedef struct _RGNRANGE {
    USHORT   usLow;
    USHORT   usHigh;
}RGNRANGE, FAR * LPRGNRANGE;

#define F_INSTRUMENT_DRUMS            0x80000000

typedef struct _MIDILOCALE {
    ULONG    ulBank;
    ULONG    ulInstrument;
}MIDILOCALE, FAR *LPMIDILOCALE;

/*
Header structures found in an DLS file for collection, instruments, and
regions.
*/

#define F_RGN_OPTION_SELFNONEXCLUSIVE 0x0001

```

DOWNLOADABLE SOUNDS LEVEL 2.1

```

typedef struct _RGNHEADER {
    RGNRANGE RangeKey;           /* Key range */
    RGNRANGE RangeVelocity;     /* Velocity Range */
    USHORT   fusOptions;        /* Synthesis options for this range */
    USHORT   usKeyGroup;       /* Key grouping for non simultaneous play
                                0 = no group, 1 up is group
                                for Level 1 only groups 1-15 are allowed */
}RGNHEADER, FAR *LPRGNHEADER;

typedef struct _INSTHEADER {
    ULONG    cRegions;         /* Count of regions in this instrument */
    MIDILOCALE Locale;        /* Intended MIDI locale of this instrument */
}INSTHEADER, FAR *LPINSTHEADER;

typedef struct _DLSHEADER {
    ULONG    cInstruments;    /* Count of instruments in the collection */
}DLSHEADER, FAR *LPDLSHEADER;

/*
 * definitions for the Wave link structure
 */

/***** For level 1 only WAVELINK_CHANNEL_MONO is valid *****/
    ulChannel allows for up to 32 channels of audio with each bit position
    specifying a channel of playback */

#define WAVELINK_CHANNEL_LEFT    0x00011
#define WAVELINK_CHANNEL_RIGHT  0x00021

#define F_WAVELINK_PHASE_MASTER 0x0001

typedef struct _WAVELINK { /* any paths or links are stored right after struct */
    USHORT   fusOptions;     /* options flags for this wave */
    USHORT   usPhaseGroup;   /* Phase grouping for locking channels */
    ULONG    ulChannel;      /* channel placement */
    ULONG    ulTableIndex;   /* index into the wave pool table, 0 based */
}WAVELINK, FAR *LPWAVELINK;

#define POOL_CUE_NULL  0xffffffffl

typedef struct _POOLCUE {
    ULONG    ulEntryIndex;   /* Index entry in the list */
    ULONG    ulOffset;      /* Offset to the entry in the list */
}POOLCUE, FAR *LPPOOLCUE;

typedef struct _POOLTABLE {
    ULONG    cbSize;         /* size of the pool table structure */
    ULONG    cCues;         /* count of cues in the list */
} POOLTABLE, FAR *LPPOOLTABLE;

/*
 * Structures for the "wsmp" chunk
 */

#define F_WSMP_NO_TRUNCATION    0x00011
#define F_WSMP_NO_COMPRESSION  0x00021

typedef struct _rwsmp {
    ULONG    cbSize;
    USHORT   usUnityNote;    /* MIDI Unity Playback Note */
    SHORT    sFineTune;     /* Fine Tune in log tuning */
    LONG     lAttenuation;   /* Overall Attenuation to be applied to data */
    ULONG    fulOptions;    /* Flag options */
    ULONG    cSampleLoops;  /* Count of Sample loops, 0 loops is one shot */
} WSMPL, FAR *LPWSMPL;

```

DOWNLOADABLE SOUNDS LEVEL 2.1

```
/* This loop type is a normal forward playing loop which is continually
   played until the envelope reaches an off threshold in the release
   portion of the volume envelope */

#define WLOOP_TYPE_FORWARD    0

typedef struct _rloop {
    ULONG cbSize;
    ULONG ulType;             /* Loop Type */
    ULONG ulStart;           /* Start of loop in samples */
    ULONG ulLength;         /* Length of loop in samples */
} WLOOP, FAR *LPWLOOP;

#endif /* _INC_DLS */
```

4.2 DLS Level 2 Header File

```

/*
    dls2.h

    Description:
    Interface defines and structures for the DLS2 extensions of DLS.

    Written by Microsoft 1998. Released for public use.

*/

#ifndef _INC_DLS2
#define _INC_DLS2

/*
    FOURCC's used in the DLS2 file, in addition to DLS1 chunks
*/

#define FOURCC_RGN2 mmioFOURCC('r','g','n','2')
#define FOURCC_LAR2 mmioFOURCC('l','a','r','2')
#define FOURCC_ART2 mmioFOURCC('a','r','t','2')
#define FOURCC_CDL mmioFOURCC('c','d','l',' ')
#define FOURCC_DLID mmioFOURCC('d','l','i','d')

/*
    Articulation connection graph definitions. These are in addition to
    the definitions in the DLS1 header.
*/

/* Generic Sources (in addition to DLS1 sources. */
#define CONN_SRC_POLYPRESSURE 0x0007 /* Polyphonic Pressure */
#define CONN_SRC_CHANNELPRESSURE 0x0008 /* Channel Pressure */
#define CONN_SRC_VIBRATO 0x0009 /* Vibrato LFO */
#define CONN_SRC_MONOPRESSURE 0x000a /* MIDI Mono pressure */

/* Midi Controllers */
#define CONN_SRC_CC91 0x00db /* Reverb Send */
#define CONN_SRC_CC93 0x00dd /* Chorus Send */

/* Generic Destinations */
#define CONN_DST_GAIN 0x0001 /* Same as CONN_DST_ATTENUATION */
#define CONN_DST_KEYNUMBER 0x0005 /* Key Number Generator */

/* Audio Channel Output Destinations */
#define CONN_DST_LEFT 0x0010 /* Left Channel Send */
#define CONN_DST_RIGHT 0x0011 /* Right Channel Send */
#define CONN_DST_CENTER 0x0012 /* Center Channel Send */
#define CONN_DST_LEFTREAR 0x0013 /* Left Rear Channel Send */
#define CONN_DST_RIGHTREAR 0x0014 /* Right Rear Channel Send */
#define CONN_DST_LFE_CHANNEL 0x0015 /* LFE Channel Send */
#define CONN_DST_CHORUS 0x0080 /* Chorus Send */
#define CONN_DST_REVERB 0x0081 /* Reverb Send */

/* Vibrato LFO Destinations */
#define CONN_DST_VIB_FREQUENCY 0x0114 /* Vibrato Frequency */
#define CONN_DST_VIB_STARTDELAY 0x0115 /* Vibrato Start Delay */

/* EG1 Destinations */
#define CONN_DST_EG1_DELAYTIME 0x020B /* EG1 Delay Time */
#define CONN_DST_EG1_HOLDTIME 0x020C /* EG1 Hold Time */
#define CONN_DST_EG1_SHUTDOWNTIME 0x020D /* EG1 Shutdown Time */

```

DOWNLOADABLE SOUNDS LEVEL 2.1

```

/*      EG2 Destinations */
#define CONN_DST_EG2_DELAYTIME          0x030F /* EG2 Delay Time */
#define CONN_DST_EG2_HOLDTIME          0x0310 /* EG2 Hold Time */

/* Filter Destinations */
#define CONN_DST_FILTER_CUTOFF          0x0500 /* Filter Cutoff Frequency */
#define CONN_DST_FILTER_Q              0x0501 /* Filter Resonance */

/* Transforms */
#define CONN_TRN_CONVEX                 0x0002 /* Convex Transform */
#define CONN_TRN_SWITCH                 0x0003 /* Switch Transform */

/*      Conditional chunk operators */
#define DLS_CDL_AND                     0x0001 /* X = X & Y */
#define DLS_CDL_OR                      0x0002 /* X = X | Y */
#define DLS_CDL_XOR                     0x0003 /* X = X ^ Y */
#define DLS_CDL_ADD                     0x0004 /* X = X + Y */
#define DLS_CDL_SUBTRACT                 0x0005 /* X = X - Y */
#define DLS_CDL_MULTIPLY                 0x0006 /* X = X * Y */
#define DLS_CDL_DIVIDE                  0x0007 /* X = X / Y */
#define DLS_CDL_LOGICAL_AND             0x0008 /* X = X && Y */
#define DLS_CDL_LOGICAL_OR             0x0009 /* X = X || Y */
#define DLS_CDL_LT                      0x000A /* X = (X < Y) */
#define DLS_CDL_LE                      0x000B /* X = (X <= Y) */
#define DLS_CDL_GT                      0x000C /* X = (X > Y) */
#define DLS_CDL_GE                      0x000D /* X = (X >= Y) */
#define DLS_CDL_EQ                      0x000E /* X = (X == Y) */
#define DLS_CDL_NOT                     0x000F /* X = !X */
#define DLS_CDL_CONST                   0x0010 /* 32-bit constant */
#define DLS_CDL_QUERY                   0x0011 /* 32-bit value returned from query */
#define DLS_CDL_QUERY_SUPPORTED         0x0012 /* 32-bit value returned from query */

/*
 * Loop and release
 */
#define WLOOP_TYPE_RELEASE 1

/*
 * DLSID queries for <cdl-ck>
 */
DEFINE_DLSID(DLSID_GMinHardware, 0x178f2f24, 0xc364, 0x11d1, 0xa7, 0x60, 0x00,
0x00, 0xf8, 0x75, 0xac, 0x12);
DEFINE_DLSID(DLSID_GSInHardware, 0x178f2f25, 0xc364, 0x11d1, 0xa7, 0x60, 0x00,
0x00, 0xf8, 0x75, 0xac, 0x12);
DEFINE_DLSID(DLSID_XGInHardware, 0x178f2f26, 0xc364, 0x11d1, 0xa7, 0x60, 0x00,
0x00, 0xf8, 0x75, 0xac, 0x12);
DEFINE_DLSID(DLSID_SupportsDLS1, 0x178f2f27, 0xc364, 0x11d1, 0xa7, 0x60, 0x00,
0x00, 0xf8, 0x75, 0xac, 0x12);
DEFINE_DLSID(DLSID_SupportsDLS2, 0xf14599e5, 0x4689, 0x11d2, 0xaf, 0xa6, 0x0, 0xaa,
0x0, 0x24, 0xd8, 0xb6);
DEFINE_DLSID(DLSID_SampleMemorySize, 0x178f2f28, 0xc364, 0x11d1, 0xa7, 0x60, 0x00,
0x00, 0xf8, 0x75, 0xac, 0x12);
DEFINE_DLSID(DLSID_ManufacturersID, 0xb03e1181, 0x8095, 0x11d2, 0xa1, 0xef, 0x0,
0x60, 0x8, 0x33, 0xdb, 0xd8);
DEFINE_DLSID(DLSID_ProductID, 0xb03e1182, 0x8095, 0x11d2, 0xa1, 0xef, 0x0, 0x60,
0x8, 0x33, 0xdb, 0xd8);
DEFINE_DLSID(DLSID_SamplePlaybackRate, 0x2a91f713, 0xa4bf, 0x11d2, 0xbb, 0xdf, 0x0,
0x60, 0x8, 0x33, 0xdb, 0xd8);

#endif /* _INC_DLS2 */

```

5. References

- The MIDI Manufacturers Association, "Downloadable Sounds Level 1" (1997)
- The MIDI Manufacturers Association, "DLS Protocol and Messaging Guidelines" (proposed 1997)
- The MIDI Manufacturers Association, "General MIDI System Level 1" (1994)
- The MIDI Manufacturers Association, "GM Developer Guidelines and Survey" (1996)

604766320Page: 1
[DLS1]Fill in numbers

604766320Page: 1
[DLS2]Fill in numbers

604766320